

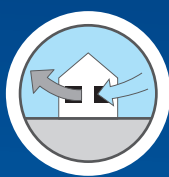

VENTILATION WITH
HEAT RECOVERY

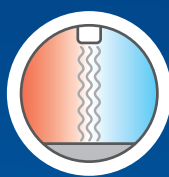

RESIDENTIAL &
COMMERCIAL
EXTRACT FANS



AIR CURTAINS



HEATING



VENTILATION



HYGIENE

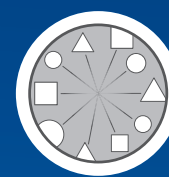

SENSORS AND
CONTROLLERS



Maico Elektroapparate-Fabrik GmbH
Industrial and Residential Ventilation



Aerex HaustechnikSysteme GmbH



Dal 1970 la ventilazione made in Italy



BSB Engineering Service Ltd.
Fire dampers



Systemhaus für Raumluftkomfort
Switzerland



Airmaster® Fan Company

USA



Member of



Italian Electric and Electronical Association



Air Movement and Control Association



Home Ventilating Institute



Italian Fire Protection Association



Work Team for the promotion of
the green building design technology



Partner of the multinational German group Maico Holding, Maico Italy S.P.A, together with both brands Elicent and Dynair, is an Italian industry specialized in building ventilation, a wide sector with multiple civil, industrial and plant application. The company has a wide and articulated offer rigorously Made in Italy: at the headquarters in Lonato del Garda (Brescia), we design and produce the whole range of fans serving the domestic and the export markets. The whole range of products are produced in the headquarters of Lonato del Garda and distributed in all Italy and in 70 countries.

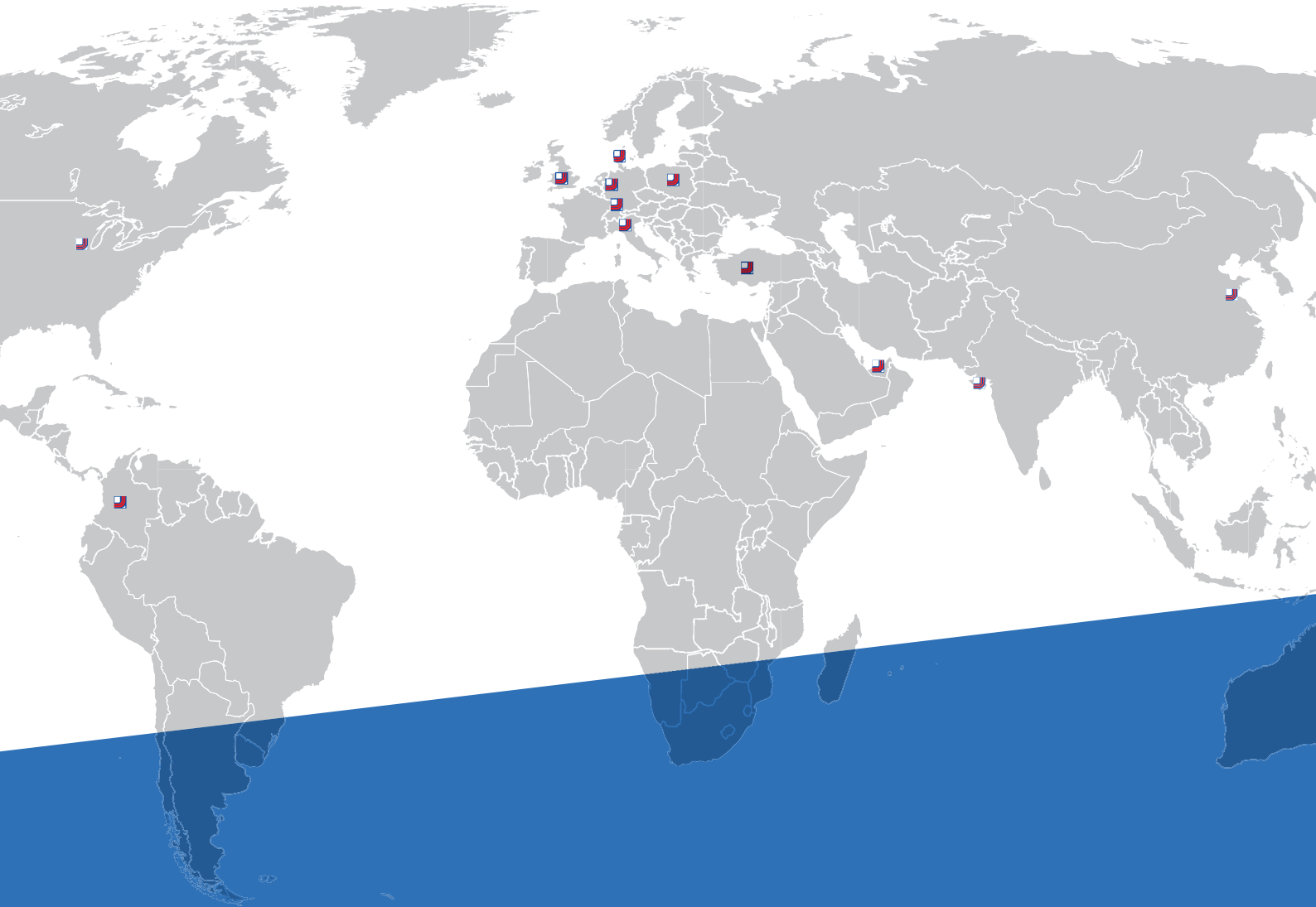

Elicent® is a brand-division of Maico Italia S.p.A. and is a well-known trademark at global level in the home use ventilation sector.

Technological expertise, high production capacities, strong research and investment policies together with a personalised back-up service focused on customer needs have been, for over 50 years, the qualities that distinguish our company: an Italian excellence renowned throughout the world and an industrial reality fortified by belonging to Maico Holding GmbH, the German group that leads the way in the ventilation industry.



We monitor the whole manufacturing process, step-by-step, from design to delivery. Punctual pre- and after-sales service has always been our great strength, as well as rigorous yet flexible logistics that enable us to operate as leaders in highly competitive markets. Our business organisation is characterised by strong coordination and cohesion in throughout every one of its stages. Every department operates in a productive system that works as a **large, efficiency-oriented organisation at your service.**



DESIGN - The design process is entrusted to highly-qualified technicians and designers who are ready to satisfy your real needs with state-of-the-art products and solutions, designed in compliance with existing regulations. Each new project is a breath of fresh air: inspired and motivated by the need to respond to certain functional and aesthetic demands, we design state-of-the-art ventilation units, studied in compliance with existing regulations in terms of safety and energy efficiency.

R&D - Continuous technical innovation, research into new functions and tests of conformity with existing regulations: our research and development department is the beating heart of our business. The competitiveness of the global market drives us and fuels our desire for progress. Our R&D team is committed day after day to the study and research of new functions, materials and technologies that we know to be fundamental to a product such as ours, on which people's safety and wellbeing depends.

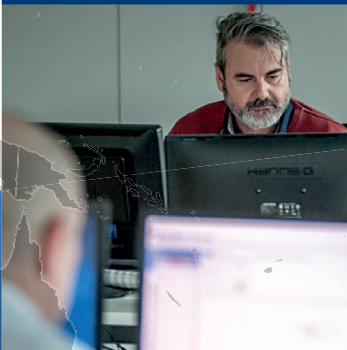

TECHNICAL & COMMERCIAL SUPPORT - We chose to work intimately: with an extensive network of 22 national manufacturer's representatives and distribution agreements or local partnerships in over 70 countries around the world, we are able to provide expert, clear and immediate commercial and technical support and maintain profitable, long-term trade relations. Besides, our team of 21 commercial experts and back-office assistants is at your service to listen and provide you with pre- and after-sales support.

PRODUCTION - 100% made in Italy, our products comply with the strictest international regulations in terms of safety and efficiency. We guarantee the production of customised ventilation units with quality standards tested in every stage of the process.



LOGISTICS - Strategic partnerships with suppliers, extensive warehouses, meticulous quality control of incoming goods and punctual shipping form the perfect cogs of a logistical process that guarantees efficiency and rapid delivery. Optimising the internal efficiency of the business and the business effectiveness toward the market are two objectives that we aim to balance every day by means of policies, tools and methods that guarantee reduced costs, optimal use of resources and the ability to satisfy customer needs in terms of quality, timing and costs. With a minimum stock of 15,000 finished products, an extensive, modern and fully-computerised warehouse and integrated logistics management, we boast incredibly quick order processing: from 48 hours for catalogue products to 20 days for special products.



The compliance of the company Quality System with UNI EN ISO 9001 standards is a guarantee of continuous alignment with customer needs. MAICO Italia certifies the compliance of the company Quality System with this legislation through the approval of an independent third party nationally and internationally recognized: CSQ (Certification Quality Systems).

In 2003 Maico Italia obtained the international certification ISO 9001 international for the high standards of its Quality system management. In 2009 the quality system was adapted to ISO 9001: 2008 and in 2016 to the new ISO 9001: 2015. In 2018 the company was also certified according to the ISO 45001: 2018 standard on management systems for health and safety at work.



All our products are CE certified and compliant with EU Directives.



The objectives of the Directive 2009/125/EC (also known as the ErP Directive or Eco-design Directive) is the framework document through which the European Union has defined the requirements for the eco-design of energy-related products (ErP, Energy Related Products). The use of the CE mark is subject to compliance with all the efficiency requirements established by the Directive.

Scope of application: As regards to the fans, divided into categories and method of installation, concrete and implementation measures have been defined by two EU Regulations:

1. Regulation No. 327/2011/EU specific to fans with power from 125 W to 500 kW which must comply with specific degrees of minimum efficiency, indicated on the documentation and motor plate with unit N. The products that fall within the scope of this Regulation are defined as "NSAIDs".

2. Regulation n° 1253/2014 (Ecodesign) and 1254/2014 (Energy labeling) specific to residential and non-residential fans with a power greater than 30 Watts and a maximum flow rate of 250 m³ / h or between 250 and 1000 m³ / h depending on the product categories. Products that fall within the scope of this Regulation are defined as "VENTILATION UNIT" (UV), which can be residential or non residential, unidirectional or bi-directional.



EC brushless motors are permanent magnet motors controlled by sophisticated electronics. Maico Italia has developed highly efficient solutions on the new generation product series.

Benefits of EC brushless motors:

- considerable reduced consumption compared to AC motors
- silence
- increase in the overall efficiency of the fan
- infinite adjustability thanks to optimized control electronics which allows to operate the motors at the speed needed



Automated test chamber for aerodynamic tests of domestic fans, compliant with the standard AMCA 210 and the international standard ISO 5801. The equipment is essential to measure the performance of appliances and their maximum efficiency, an increasingly critical parameter in an energy saving scenario.

Direct Line

+36-1-425-0353
info@elicient.hu



www.elicient.hu



SELECTING THE CORRECT FAN

Extraction is always made from humid/polluted premises: kitchens, laundries, toilets, bathrooms, bars... To choose the fan airflow needed for a specific application, use the following calculation:

$$\text{Airflow} = \text{volume of the room in m}^3 \times \text{number of air changes per hour}$$

Type of room	Air change per hour
Kitchens	6 - 10
Bathrooms and shower rooms	8 - 12
Toilets	8 - 10
Public toilets	10 - 15
Restaurants and bars	10 - 12

SETTING THE FAN CORRECTLY

- Fans should always be mounted in the furthest window, wall or ceiling from the main source of air replacement to ensure airflow across the room and avoiding short circuiting of air movement.
- Air replacement should be ensured via internal grilles in the door, ceiling or wall.
- Fans should be located as high as possible in the window or wall nearest to smells or streams but not directly above eye-level grilles or cooker hoods.

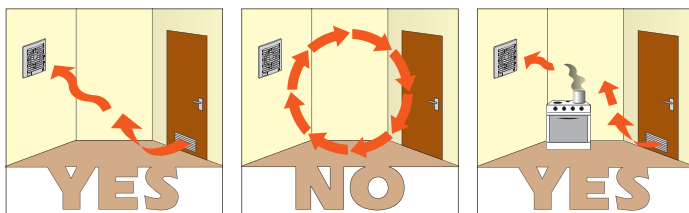

- If installing in a bathroom, the fan must be located where it cannot be touched by a person. Elicent range of 12 Volt SELV fans (Safety Extra Low Voltage) can be installed in zone 1. Fans with IPX4 protection can be installed in zone 2. Fans with an IPX2 protection must be installed in zone 3.

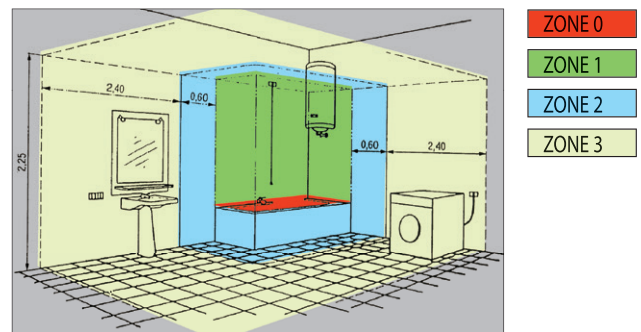

CHOOSING THE RIGHT ELICENT VERSION

● IDEAL SOLUTION
 ✓ SUITABLE
 ✗ NOT RECOMMENDED

TYPE OF PREMISE	BASE	PULL CORD SWITCH	TIMER/COMFORTIMER	MHT / COMFORT HYGRO	MHY SMART	PIR	2 SPEED
TOILET	✓	✓	✓	✓	✗	✓	✓
PUBLIC TOILET	✓	✓	✓	✓	✗	✓	✓
BATHROOM	✓	✓	✓	✓	✓	✗	✓
SHOWER ROOM	✓	✓	✓	✓	✓	✗	✓
KITCHEN	✓	✓	✓	✓	✓	✗	✓
LAUNDRY	✓	✓	✓	✓	✓	✗	✓
OFFICE	✓	✓	✓	✗	✗	✗	✓

OPERATION

BASE version
Light/remote control switch.

PULL CORD switch

TIMER
Integral electronic timer adjustable from 3 to 25 minutes.

CMT - COMFORTIMER - Microchip Timer version adjustable from 3 to 25 mn with overrunning at low speed for an energy saving up to 64% compared to a standard timer version. The low speed guarantees increased silence and energy saving though maintaining a fully satisfying exhausting efficiency. Version particularly suitable for hotels, hospitals, private homes and for all those applications where silence is a must.

MHT humidity control
Integral humidity control adjustable from 40 to 80% of R.H. and Timer adjustable from 3 to 25 minutes.

MHY Smart humidity control
Provided with the latest microchip technology. Operation: automatic and progressive increase / decrease of the motor speed according to the percentage of R.H.

COMFORT HYGRO
Combines to Comfortimer technology a microchip humidity sensor adjustable from 40 to 80% of Relative Humidity.

P.I.R. - Passive infra-red sensor with integral adjustable timer from 3 to 25 minutes.

SELV 12 VOLT - Low voltage version.

2 V - Double speed version (24 hours running at the lowest speed).

EC MOTOR - High efficiency, electronically controlled, brushless motor.

PRODUCT SPECIFICATION

INSTALLATION

Direct exhaust to the outside

Ducted installation

CERTIFICATIONS

IMQ approved

Product compliance with EC Directive

PROTECTION

Double insulation Class II earth connection not required

International Protection rating

Splash proof protection (EN 60335-2-80)

Drop protection (EN 60335-2-80)

Maximum operating temperature



VENTILATION WITH HEAT RECOVERY

Decentralized HRU		pag.
	REC Smart Single Room HRU	12
	REC Smart PLUS Single Room HRU	14
	REC Duo 100 Single Room HRU	16
	REC San Air Single Room HRU	18
Centralized HRU		pag.
	REC in linea HRU horizontal installation	24
	REC 280 - 320 HRU vertical installation	28



EXTRACT VENTILATION

Centralized extract ventilation		pag.
	MICROBOX	33
	MULTIBOX	34
	EXT	35
	MRF	36
	AXC	37
	AXC TP	38
	AXM	39
Decentralized extract ventilation		pag.
AXIAL FANS		
	E-SMILE	42
	ELEGANCE	43
	E-STYLE PRO	44
	E-STYLE PIR PRO	45

		pag.
	E-STYLE TREND	46
	ECOLINE	47
	MINISTYLE	49
	MURO	50
	TUBO	51
	BUILT-IN	52
	JOLLY PLUS	53
	ECOWIND	54
	VITRO	55
	MINIVITRO	57
CENTRIFUGAL FANS		
	ELIX	58
	ELPREX	59
	FLUX	61
	RADIA	62
	TIRAFUMO	63
SPINNING CHIMNEY COWLS		
	ELIAIR	64
RADON MITIGATION		
	AXR	66
EC BRUSHLESS RANGE		
	E-MAX	69
	ELEGANCE EC 2V	71
	ELIX EC 2V	72
	EXT EC	73
	MRF EC	74
	AXC EC	75

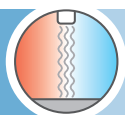



AIR CURTAINS

		pag.
	ELDOOR CZ	78
	ELDOOR TZ	78



VENTILATION

		pag.
	POLAR EVOLUTION Reversible ceiling fans	85
	MP800 Air scatters	86









HEATING

		pag.
	CALDO 500	80
	CALDO BAGNO 2000	80
	CALDO LAMP 1500 GOLD	81
	CALDO LAMP 1500	81
	CALDO TURBO 2000 TECH	82
	CALDO TURBO / CALDO 2000	82
	VOLCANO R	83
	VOLCANO PRO	83



HYGIENE

		pag.
	ECOJET Ecological and high speed hand-dryer	89
	ECOFLOW Ecological antivandal hand-dryer	90
	HD 300 Antivandal hand-dryer	91
	HD 100 Classic hand-dryer	92
	HR 100 Hair dryer	93
	ECODRYER Hair dryer	94
	ECOCLEAN Hand Sanitizer dispenser	95

 EC versions

SENSORS - CONTROLLERS - ACCESSORIES

96

HEAT RECOVERY VENTILATION

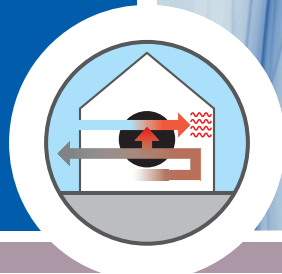

FACTS & FIGURES

When talking about pollution, we use to think exclusively to the atmospheric pollution. Anyway, the air we breathe at home, in the office or at school – where we spend around 90% of our time – is much more polluted than the outdoor one.

- The problem, known and recognized by the scientific community, is called the Sick Building Syndrome (SBS)
- 20% of the buildings suffer from problems of humidity which are the cause of many allergic and respiratory pathologies
- The indoor air pollutants cause the death of 4 million persons each year

In its Indoor Air Quality Guidelines of 2009, The World Health Organization recommends that a **correct air exchange** is made in order to maintain a minimum comfort and to prevent pathologies caused by an excessive exposure to indoor air pollutants.

Opening the windows to change the indoor air is a natural and spontaneous behaviour which is anyway very onerous in terms of thermal energy loss (heated or cooled air). Besides, it even worsens the indoor air quality.

Today, ventilating means to renew the indoor air in a controlled and measurable way with optimized energy costs.

THE SOLUTION

Ventilation with heat recovery is a clean and simple technology which provides great comfort and savings: it enables to create an hygienic microclimate throughout the home, **combining comfortable living, protection of the building and energy efficiency:**



WELL BEING

- **Fresh, clean air at a comfortable temperature** improves your quality of life and sleep.
- **A clean and filtered air** prevents allergens from multiplying and promotes the removal of pollutants.
- **Low noise level:** quiet equipment operation and protection from external noises.



SAVINGS

- **Lower heating and air conditioning bills.**
- **Low energy consumption.**
- **Optimising insulation investments** (window frames, wall and loft insulation, roof) which would be wiped out with a natural ventilation system: **on average, in fact, open windows lead to a loss of 50% of heat from the home.**



COMFORT

- **Practical, versatile and customisable modular operation.**
- **A reliable system** which ensures the correct ventilation in every season.
- The ideal **solution for energy requalification** of buildings.



PROTECTING YOUR PROPERTY

- **Preventing damage caused by dampness and condensation.**
- **Preventing mould.**
- Protecting the **value of your property.**

DECENTRALIZED HRU

A simple and smart innovation



5 Good reasons to choose it:

- Need to better the indoor air quality with punctual solutions for each kind of room
- Presence of an air quality or ventilation problem limited to a unique room or a small house
- Impossibility to install a centralized HR system
- Need to renovate or requalify the house at limited costs
- Avoid important masonry interventions

Single and integrated solutions for the comfort of the whole house

REC^{smart}



STANDARD version

HUMIDITY CONTROL version

REC^{smart+}



Version with **REMOTE CONTROL**

Version with **TOUCH CONTROL**

Single room HRU

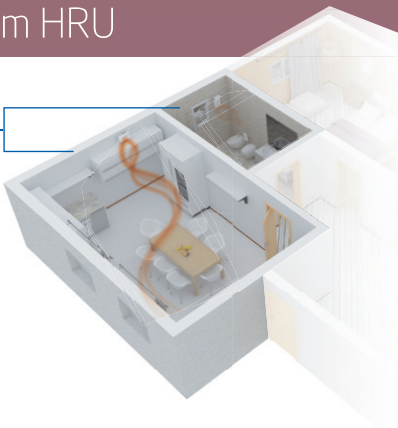

Ø100 mm

REC^{SanAir}



REC SanAir WALL



REC SanAir WALL IN



REC SanAir WINDOW

Single - Room HRU

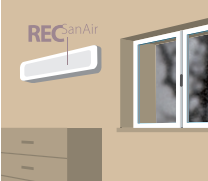

REC SanAir WALL



REC SanAir IN WALL



REC SanAir WINDOW

REC^{duo}₁₀₀

STANDARD / 2V version

REC DUO 100 MHY
Humidity control version

REC DUO 100 PLUS RC
Full optional version with remote control

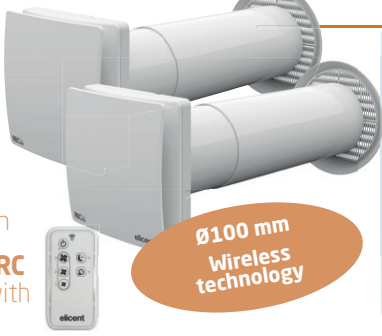

Ø100 mm
Wireless technology

HRU for installation in single or separate rooms





For single rooms
up to 40 m²



Complies with ErP Directive and
UE Regulation 1253/2014
Residential Ventilation Unit (VU)

Energy class B

- Thermal efficiency up to **75%**
- Easy to install: no ducting system or heavy masonry required.
A hole of Ø100 mm is sufficient
- Ideal for refurbishment and energy requalification
- Drastic solution to humidity and condensate problems
- EC motors

OPERATION

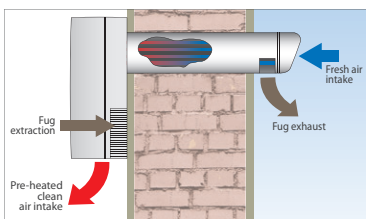

- Tubular heat exchanger with separate flows for a perfect hygiene.
- Balanced double flow, 24/7 running.

CONTROLLER



Built-in installation



RLS - Remote Speed control (min-max) and on/off switch.

- New design with cover
- Suitable for surface or built-in installation
- Ease of connection by the means of removable terminals
- Protection IP42
- Weight 0,40 Kg
- Supply voltage 230V – 50/60 Hz
- Dimensions 110 x 80 x 42

Supplied as accessory.
Indispensable
with standard version.

See pag. 98

FEATURES

- 3 models with duct Ø 100 mm and 3 standard lengths for wall thickness up to 600 mm.
- Suitable for any kind of room. Ideal for wet rooms like kitchens and bathrooms.
- Extremely compact and versatile: can be installed in horizontal or vertical position.
- High energy saving thanks to EC motors
- Integrate by-pass and antifreeze functions.
- Provided with 3 filters: the air is filtered in both flows before entering the heat exchanger.
- Easy maintenance and cleaning: filters and heat exchanger are removable and washable.
- Complies with EN 60335-2-80, LVD 2014/35/EU, EMC 2014/30/EU.

PERFORMANCE

MODELS	DUCT	WALL THICKNESS	V	m ³ /h	l/s	W	A	dB(A)		Kg
	Ø mm	max mm						LwA	LpA*	
BASE Version / 24 hours running / Timer										
REC Smart 100/400	100	400	230	27 / 53	8 / 15	8,3 / 28,3	0,075 / 0,207	48,3 / 59,4	27,7 / 39,3	3,8
REC Smart 100/500	100	500	230	27 / 51	8 / 15	8,3 / 28,3	0,075 / 0,207	48,3 / 59,4	27,7 / 39,3	3,9
REC Smart 100/600	100	600	230	27 / 50	8 / 15	8,3 / 28,3	0,075 / 0,207	48,3 / 59,4	27,7 / 39,3	4,0
MHY Version / 24 hours running / Humidity control - Timer										
REC Smart 100/400 - MHY	100	400	230	27 / 53	8 / 15	8,3 / 28,3	0,075 / 0,207	48,3 / 59,4	27,7 / 39,3	3,8
REC Smart 100/500 - MHY	100	500	230	27 / 53	8 / 15	8,3 / 28,3	0,075 / 0,207	48,3 / 59,4	27,7 / 39,3	3,9
REC Smart 100/600 - MHY	100	600	230	27 / 53	8 / 15	8,3 / 28,3	0,075 / 0,207	48,3 / 59,4	27,7 / 39,3	4,0

* Lp(A) measured at 3 m in open field 230V-50 Hz



Filter holder and F7 filter
(upon request)

INSTALLATION EXAMPLES



Suitable for any kind of room Ideal for wet rooms like kitchens and bathrooms.

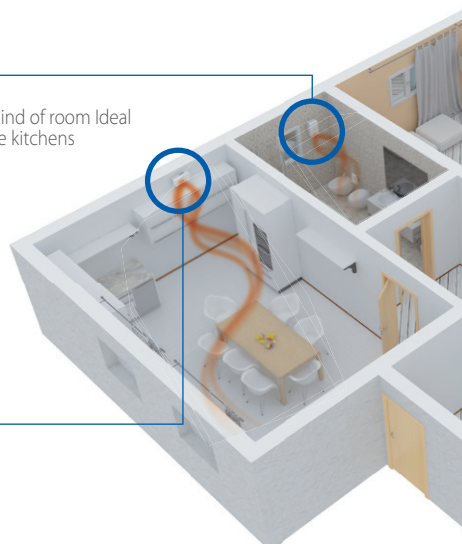



VERSIONS

BASE version



I 24/7 running at the minimum speed.



II The unit switches at the highest speed through a manual command on a remote control (switch, push button or RLS controller).

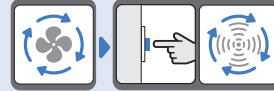

III The highest speed is provided with a timer (adjustable from 0 to 30 minutes). At the end of the delay running, the fan automatically turns back to the minimum speed.



MHY Version Humidity control



I 24/7 running at the minimum speed.



II The unit switches to the highest speed automatically through the humidity sensor. The maximum speed is reached progressively according to the humidity level of the room.

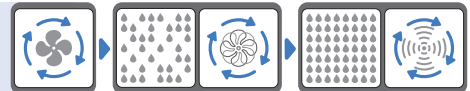

III Once the humidity goes under the pre-set level (adjustable from 40 to 90% of R.H.), the unit automatically switches to the minimum speed.

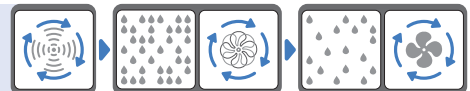

Also the MHY version is provided with a timer adjustable from 0 to 30 minutes for the manual boost at the maximum speed. The function is useful in case it is necessary to have the fan running at the maximum speed independently from the humidity level (see point III base version).



DIMENSIONS (mm)

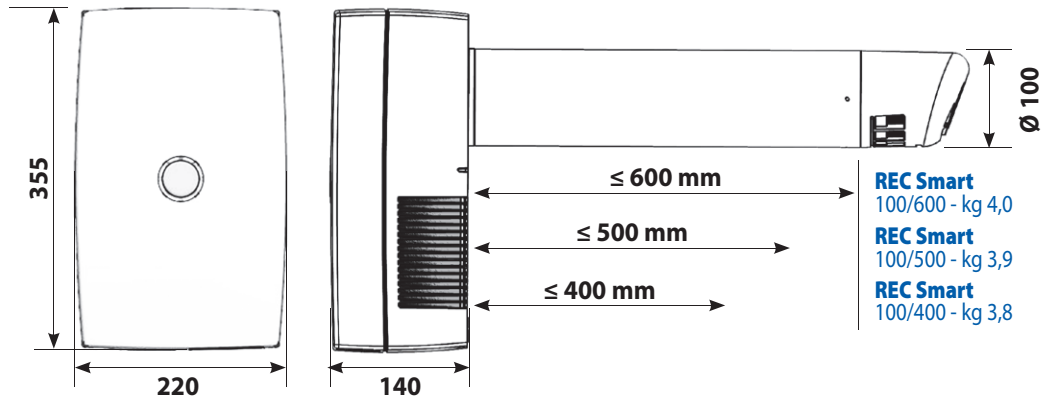

INSTALLATION

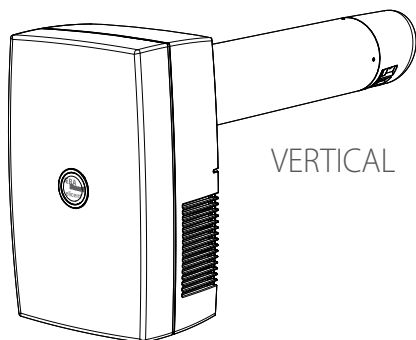

VERTICAL

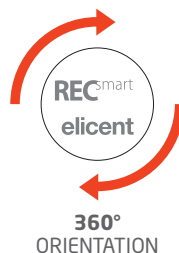

360° ORIENTATION

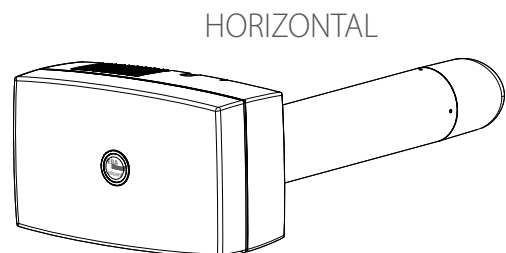

HORIZONTAL



For single rooms
up to 40 m²



Complies with ErP Directive 2009/125/CE
and EU Regulation 1253/2014
Residential Ventilation Unit

Energy class B

- Integrated Humidity Control
- Thermal efficiency up to **75%**
- Easy to install: no ducting system or heavy masonry required.
A hole of Ø100 mm is sufficient
- Ideal for renovation and energy requalification
- Drastic solution to humidity and condensation
- EC motors

OPERATION

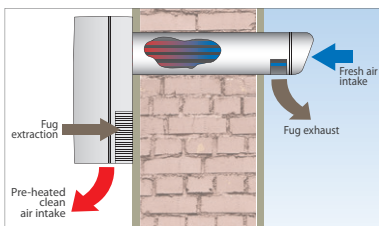

- Tubular heat exchanger with separate flows for a perfect hygiene.
- Balanced double flow, 24/7 running.

FEATURES

- **REC Smart+** is available in a range of 3 models corresponding to 3 different duct lengths, with a unique duct diameter 100 mm. The measures reported on the dimensional drawing refer to the maximum thickness of the wall on which the ventilation unit can be installed: 400, 500, 600 mm.
- 3 models with duct Ø100 mm and 3 standard lengths for wall thickness up to 600 mm.
- Suitable for any kind of room. Ideal for wet rooms like kitchens and bathrooms.
- Extremely compact and versatile: can be installed in horizontal or vertical position.
- High energy saving thanks to EC motors.
- Integrated by-pass and antifreeze functions.
- Provided with 3 filters: the air is filtered in both flows before entering the heat exchanger.
- Easy maintenance and cleaning: filters and heat exchanger are removable and washable.
- Complies with EN 60335-2-80, LVD 2014/35/EU, EMC 2014/30/EU.

OPERATION

REC Smart+ is designed for a 24 hours running at the minimum speed. The unit switches at the highest speed through a manual command on a remote controller (remote switch / push button, radio controller or Touch Panel) or automatically (through the integrated humidity sensor or via the Touch Panel weekly programming). Both models RC and TC are provided with the MHY Smart humidity control (a technology patented by Maico Italia) which allows to have the ventilation speed automatically set according to the detected humidity level. The BOOST function (maximum speed) is provided with a timer (adjustable from 0 to 30 minutes) that can be activated through remote controller (switch, light switch, radio controller, touch panel). The function is useful in case it is necessary to have the unit running at the maximum speed independently from the humidity level.

MODELS

RECsmart+ RC

The model is supplied with a remote radio controller. The ventilation unit is provided with 3 LED that indicate the operation modality, including the sleep mode and the extraction mode, as well as the indication of potential anomalies.



Through the remote radio controller it is possible to activate the following functions:

- On/Off
- Speed/ventilation level regulation
- Sleep modality that allows to have the unit running silently at low speed during the night (the boost function is excluded)
- Post-ventilation function (Timer function, adjustable from 0 to 30 minutes) to delay the switching of the unit at the minimum speed

RECsmart+ TC

The model is supplied with a remote Panel Touch controller with coloured screen.



The Touch Panel allows to manually or automatically activate (through the weekly programming) the following functions:

- Speed/ventilation level regulation
- Ventilation modality (by-pass function, free-cooling, extraction only, immission only)
- Threshold humidity level over which the unit increases its speed
- Post-ventilation function (Timer function, adjustable from 0 to 30 minutes) to delay the switching of the unit at the minimum speed)
- Sleep modality that allows to have the unit running silently at low speed during the night (the boost function is excluded)



PERFORMANCE

MODELS	DUCT Ø mm	WALL THICKNESS max mm	V	m³/h	l/s	W	A	dB(A)		Kg
								LwA	LpA*	
RC RECsmart+ RADIO CONTROL										
REC Smart+ L400 + REMOTE CONTROLLER	100	400	230	27 / 53	8 / 15	8,3 / 28,3	0,075 / 0,207	48,3 / 59,4	27,7 / 39,3	3,8
REC Smart+ L500 + REMOTE CONTROLLER	100	500	230	27 / 51	8 / 15	8,3 / 28,3	0,075 / 0,207	48,3 / 59,4	27,7 / 39,3	3,9
REC Smart+ L600 + REMOTE CONTROLLER	100	600	230	27 / 50	8 / 15	8,3 / 28,3	0,075 / 0,207	48,3 / 59,4	27,7 / 39,3	4,0
TC RECsmart+ TOUCH CONTROL										
REC Smart+ L400 + TOUCH PANEL	100	400	230	27 / 53	8 / 15	8,3 / 28,3	0,075 / 0,207	48,3 / 59,4	27,7 / 39,3	3,8
REC Smart+ L500 + TOUCH PANEL	100	500	230	27 / 53	8 / 15	8,3 / 28,3	0,075 / 0,207	48,3 / 59,4	27,7 / 39,3	3,9
REC Smart+ L600 + TOUCH PANEL	100	600	230	27 / 53	8 / 15	8,3 / 28,3	0,075 / 0,207	48,3 / 59,4	27,7 / 39,3	4,0

* at 3 m in open field

DIMENSIONS (mm)

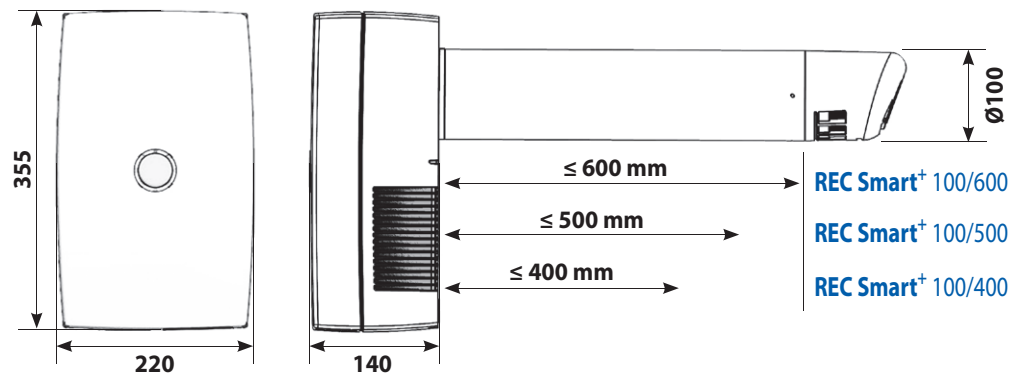

INSTALLATION

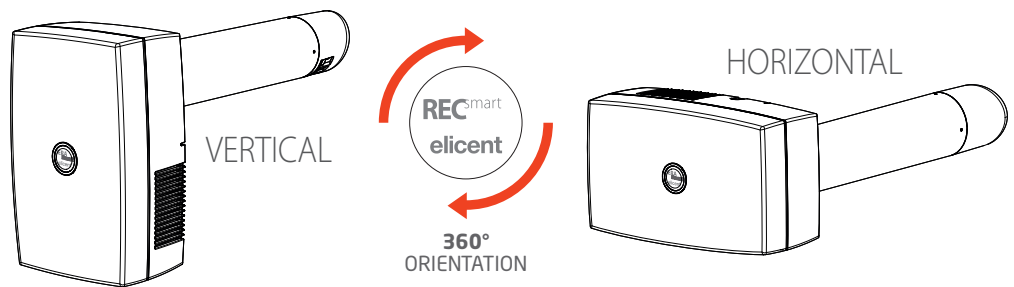

REMOVE MOULD AND BREATHE A HEALTHIER AIR!



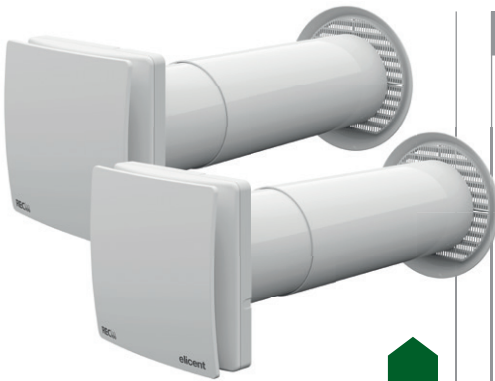

Coupled installation in a single room or 2 separate rooms



Complies with ErP Directive 2009/125/CE and EU Regulation 1253/2014 Residential Ventilation Unit

FEATURES

- Very high efficiency decentralized HRU with heat recovery up to 90%.
- Ideal for residential applications and in any environment where it is necessary to ensure a constant thermal comfort both in summer and in winter.
- Suitable for any kind of room.
- A coupled installation is recommended to optimize the system's efficiency, in a single room or in separate rooms.
- Direct exhaust through walls with thickness from 300 to 500 mm (adaptable to other wall thicknesses from 220 to 1000 mm: see section Dimensions).
- Suitable for conveying air to a max. temperature of 40°C.
- Stylish and ultra-slim front cover. Very compact dimensions.
- Provided with G3-class filters both in intake and in extract, easily removable and washable.
- Free-cooling function.
- EC brushless motor.
- Complies with EN 60335-2-80, LVD 2014/35/EU, EMC 2014/30/EU.
- IPX4
- CE marked

Energy class A

- Thermal efficiency up to **90%**
- Ø100
- Easy Installation and maintenance:
 - Magnetic coupling/uncoupling of the unit
 - External grille with net, installable from the inside
 - Telescopic duct
- Wireless technology (REC duo 100 PLUS RC)
- Drastic solution to humidity and condensation problems

OPERATION



REC Duo 100 is a "push-pull" HRU with reverse flow. It is provided with a ceramic heat exchanger that accumulates the heat from the extracted air during the "pull" cycle and releases it to the new fresh air during the "push" cycle.

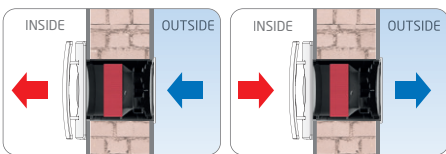

REVERSE FLOW **60** SECONDS

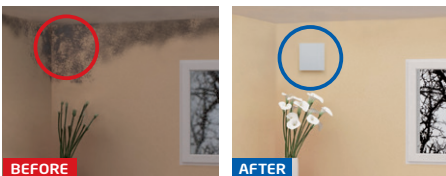

EXAMPLES OF INSTALLATION

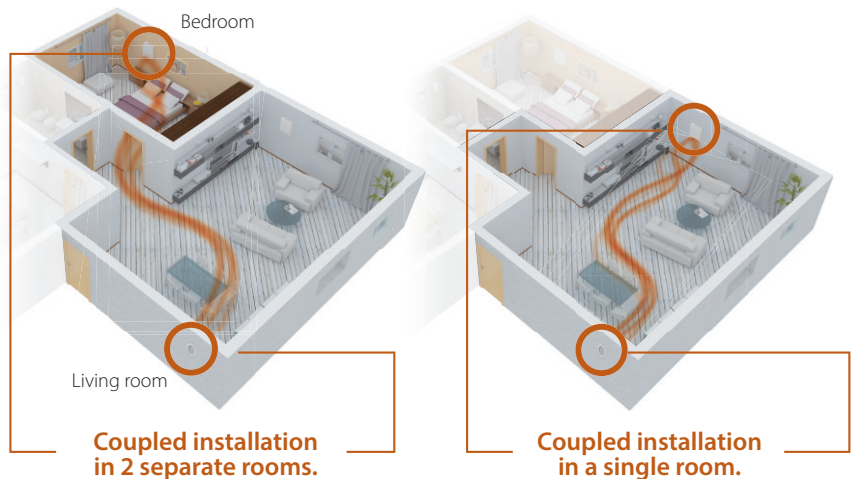

PERFORMANCE

MODEL	DUCT	WALL THICKNESS	AIR FLOW min / max only exhaust	V AT 50 HZ.	W min / max only exhaust	dB(A)*
	Ø (mm)	min. / max (mm)	m³/h			
REC Duo 100 - 100 MHY - 100 Plus RC	107	300 - 500	12 / 30 / 40	230	1 / 2,8 / 3,5	15 / 29

* at 3 m in open field

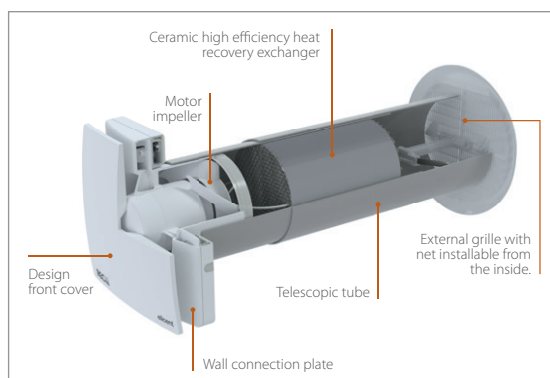

MAGNETIC COUPLING UNCOUPLING OF THE UNIT TO THE CONNECTION PLATE





MODELS & OPERATION



REC DUO 100

24 hours running in push-pull modality at low speed (selectable between 2 at installation). The unit switches to the extraction operation modality when speed boost is activated through remote control switch or RLS controller (available as accessory). The maximum speed is provided with a timer (adjustable from 0 to 30 minutes). Once concluded the overrun via timer, the fan automatically switches back to the push-pull operation modality at low speed.



REC DUO 100 MHY

24 hours running in push-pull modality at low speed (selectable between 2 at installation). The unit switches to the extraction operation modality when speed boost is activated, manually or automatically: **Manually** via control switch or RLS controller (available as accessory). The maximum speed is provided with a timer (adjustable from 0 to 30 minutes). Once concluded the overrun via timer, the fan automatically switches back to the push-pull operation modality at low speed. **Automatically** via humidistat (adjustable from 45 to 85% of R.H). The fan speed increases/decreases according to the humidity level detected above the pre-selected threshold. It then switches back to the push-pull operation modality at low speed when the humidity level goes beneath the pre-selected threshold.

RLS

Available upon request as accessory for REC DUO 100 and REC DUO 100 MHY



- On-Off
- Boost speed



RC REC DUO 100 PLUS RC

24 hours running in push-pull modality at low speed (adjustable by the end-user). Boost speed is available in push-pull modality and turns on automatically via humidistat (adjustable from 45 to 85% of R.H) and increases/decreases progressively according to the detected humidity level. In case of a persistent and high concentration of humidity, the unit automatically switches to the extraction operation modality. It then switches back to the push-pull operation modality at low speed when the humidity level goes below the pre-selected threshold. The unit is supplied with a remote controller for the selection and activation of advanced comfort ventilation functions.

REC Duo 100 PLUS RC is supplied with a remote controller, to select the speed and activate the following operation modalities:

0 - On/off

1 - Push-pull operation modality

24 hours reverse flow running at the selected speed

2 - Speed 1 - Low speed set up

3 - Speed 2 - Low speed set up

4 - Boost speed with timer (extraction mode only)

5 - Sleep mode

the operation at low speed is frozen for 8 hours to ensure high acoustic comfort during the night. The function can be unblocked at any time by pressing any button (except button 0).

6 - Flow control

operation in intake or extract mode only.

Press once: extraction mode

Press twice: intake mode

7 - Free-cooling mode: air exchange without heat recovery

No reverse flow. Press once: the reverse flow stops and the fans go on running at the current flow. Press twice: all fans reverse their flow and go on running at the new selected flow.

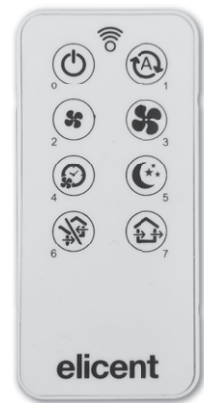

Led signal:

any time a button is pressed, a led switches on the remote controller to indicate that the signal has been received.

DIMENSIONS (mm)

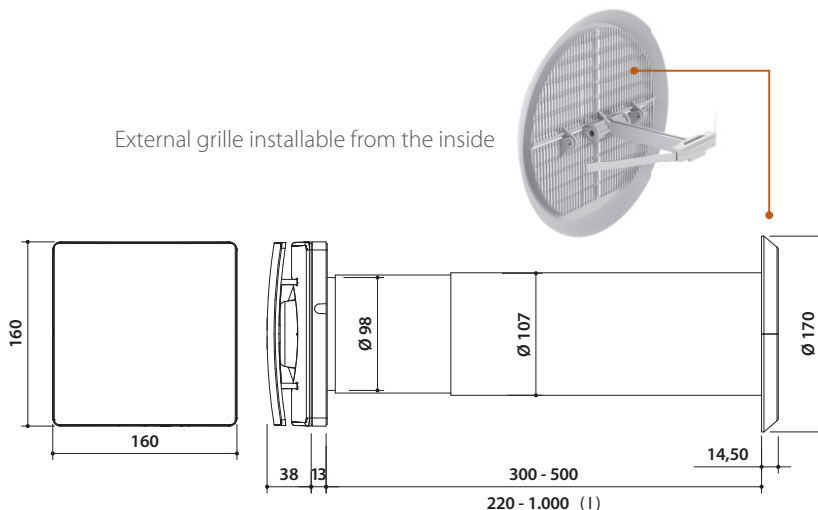

(I)

- For walls with thickness > 500 mm:

It is necessary to use the telescopic duct available as accessory

Cod. 2KT0014



- For wall thickness between 220 and 300 mm:

it is necessary to cut the duct and to use the external grille MFE, available as accessory

Cod. 2GE2002





REC SanAir **WALL**



REC SanAir **WALL IN**



REC SanAir **WINDOW**



Single rooms up to 40 m²

Complies with ErP Directive 2009/125/CE and EU Regulation 1253/2014

Classification: Residential Ventilation Unit

Energy class A

- Technical data certified according to EN 13141-8
- Thermal efficiency up to 82%
- Highly efficient filtering system F9 + G4 which allows the retention
- Enthalpic heat exchanger
- EC Motor

REMOTE CONTROL



REC San Air is supplied with a remote control for the set-up of the ventilation level and the free cooling function (with programmable timer up to 10 hours).

FEATURES

- Decentralised heat recovery unit with high efficiency enthalpic heat exchanger for residential application.
- Thermal efficiency up to 82%.
- With double filter F9 + G4 **which allows the retention** of at least 98% of PM2,5, 99,5% of PM10, 100% of pollens and at least 80% of PM1
- Ultra slim and aesthetic design. Lightweight and easy to install.
- Wall/window frame installation
- 5 ventilation levels: from 15 to 41 m³/h.
- Free-cooling and Antifreeze functions.
- Low consumption: from 4 W
- High acoustic insulation: Dnew: 55dB
- Complies with B.T. 2014/35/UE, EMC 2014/30/UE.
- CE marked

PERFORMANCE

SPEED	AIRFLOW	ELECTRIC POWER W	SOUND PRESSURE dB (A)		THERMAL EFFICIENCY %
	m ³ /h		Lw	Lp	
1	15	4,6	37	19	82
2	20	5,8	40	22	79
3	30	10,3	45	27	74
4	35	14,6	48	30	72
5	41	20,6	51	33	69

TECHNICAL DATA

Heat recovery depending in T, RH, AIRFLOW	up to 82%
Rated input voltage	220 V a.c.
Internal operating voltage	24V c.c.
Power supply	230V / 50 Hz
Safety class	II
Safety	Transformer provided with thermal protection
Protection grade	IPX4
Connection cable length	2,5 mt
Temperature range	Min. -20°C / Max 50°C
Thermal transmission coefficient	U = 0,3 W / m ² K
Noise attenuation	Dnew = 55 dBA
Provided filters	F9 + G4 - immission





MODELS

REC SanAir WALL

- Installation on all kind of perimeter wall.
- Unique model for horizontal or vertical installation.
- Easy installation: 2 holes of Ø80 mm are sufficient.



INSTALLATION

PRODUCT

MODEL

REC SANAIR WALL - Wall installation - Horizontal or vertical installation



REC SanAir WALL

REC SanAir WINDOW

- Installation on all kinds of window frame with dimensions up to 180 mm of width and 3000 mm of length.



INSTALLATION

PRODUCT

MODEL

REC SANAIR WINDOW - Window installation



REC SanAir WINDOW

Frame for
REC SanAir WINDOW

L. 1.000 White RAL 9010

L. 1.500 White RAL 9010

L. 2.000 White RAL 9010

L. 2.500 White RAL 9010

L. 3.000 White RAL 9010



MODELS

REC SanAir WALL IN

- Installation on any kind of perimetrical wall.
- Built-in horizontal or vertical installation.

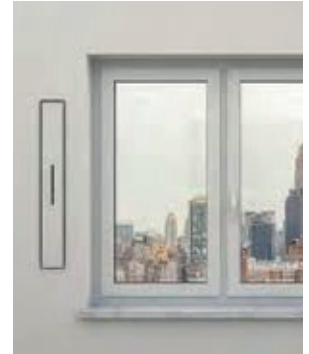

INSTALLATION	PRODUCT	MODEL
REC SANAIR WALL IN	Built-in horizontal or vertical installation with DIRECT OUTPUT	
		REC SanAir WALL IN
		Built-in frame with rear in EPS
	EXTENSIONS	
		External extensions for REC SanAir with direct output
		External extensions 45° curved for REC SanAir 45° (to form a curve of 90°)
	COVER	
		REC San Air white cover RAL 9016
		Kit cover flush with the wall
	Built-in horizontal or vertical installation with PERPENDICULAR OUTPUT	
		REC SanAir WALL IN
		Built-in frame in EPS with rear + 90° curve
	EXTENSIONS	
		External direct extensions
	COVER	
		REC San Air white cover RAL 9016
		Kit cover flush with the wall



with 5KT0009 and protruding cover 5FR0000

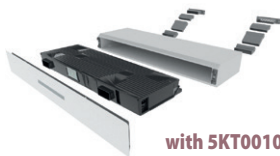



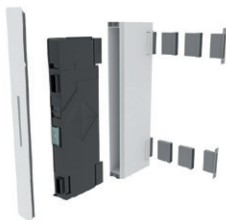

with 5KT0010





ACCESSORIES / SPARE PARTS

	Direct extension kit - 10 pcs
	Remote controller
	Filter G4 + F9 x 2 pcs
	Template for flush to the wall
	HEPA filter

DIMENSIONS (mm)

Dimensions Version WALL

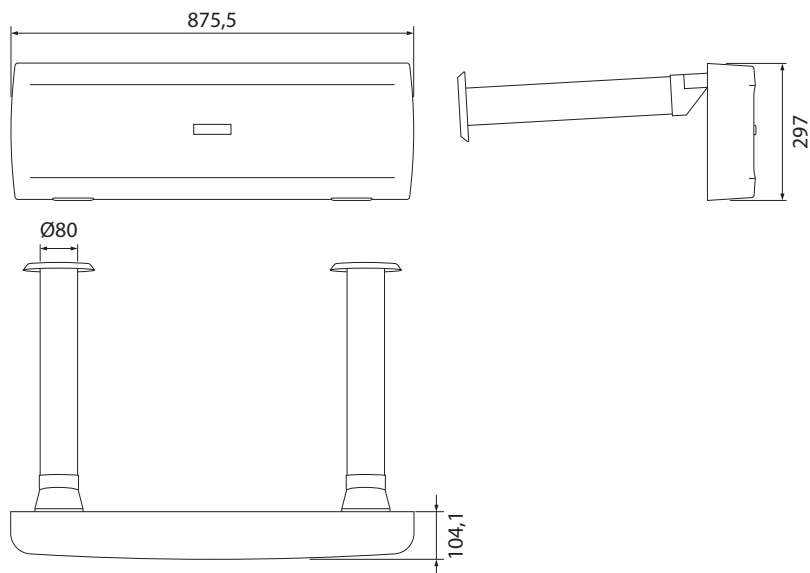

Dimensions Version WINDOW

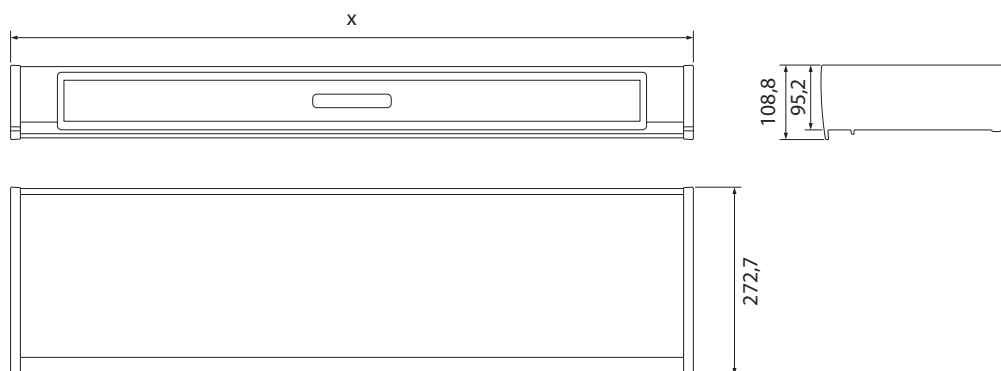



DIMENSIONS (mm)

Dimensions Versions WALL IN

Horizontal configuration with cover flush with the wall

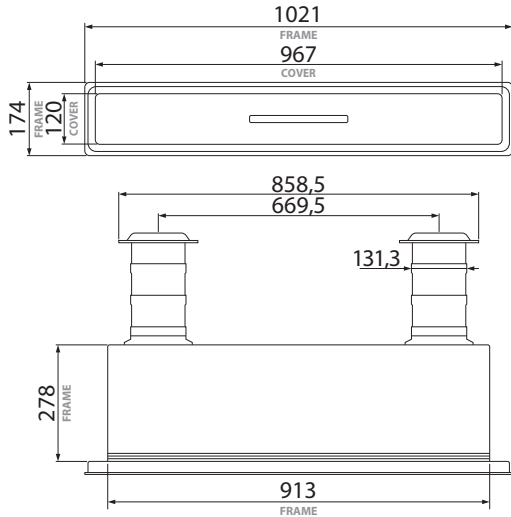

X MAX mm	SPIGOT L = 70 mm	EXTENSION L = 75 mm
396	1+1	NO
471	1+1	1+1
546	1+1	2+2
621	1+1	3+3
696	1+1	4+4
771	1+1	5+5
846	1+1	6+6

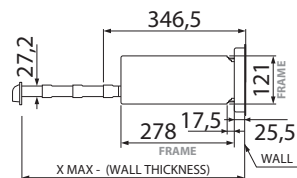

In case of wall thickness < to the measures indicated it is sufficient to cut the extensions or spigots on site.

Horizontal configuration with external cover

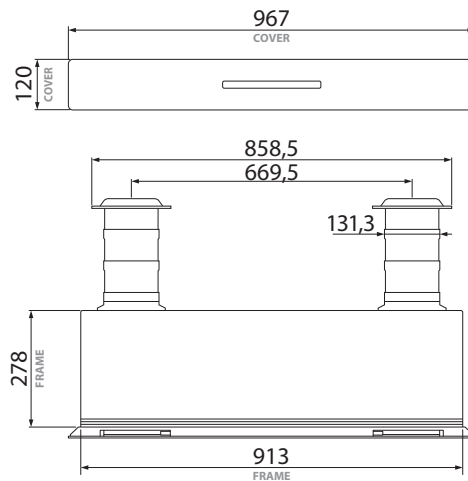

X MAX mm	SPIGOT L = 70 mm	EXTENSION L = 75 mm
371	1+1	NO
446	1+1	1+1
521	1+1	2+2
596	1+1	3+3
671	1+1	4+4
746	1+1	5+5
821	1+1	6+6

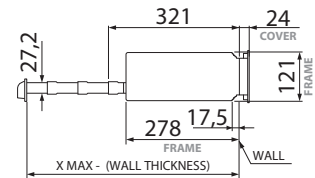

In case of wall thickness < to the measures indicated it is sufficient to cut the extensions or spigots on site.

Vertical configuration with cover flush with the wall

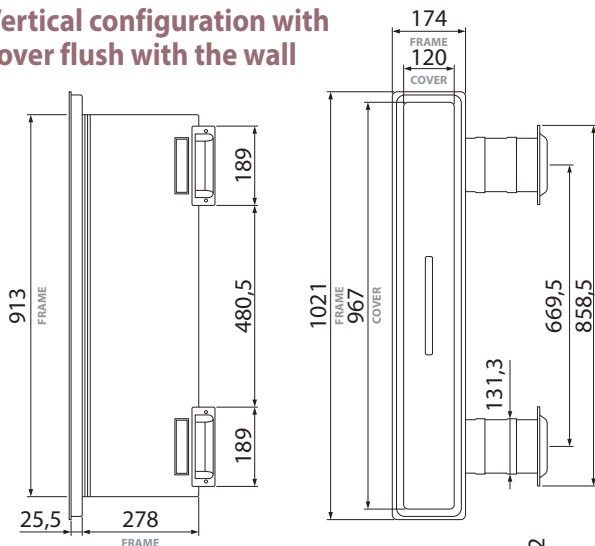

X MAX mm	SPIGOT L = 70 mm	EXTENSION L = 75 mm
48	1+1	NO
123	1+1	1+1
198	1+1	2+2
273	1+1	3+3

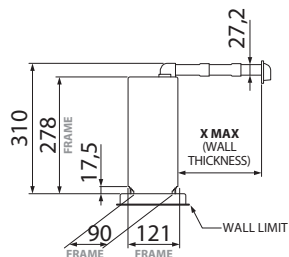

In case of wall thickness < to the measures indicated it is sufficient to cut the extensions or spigots on site.

Vertical configuration with external cover

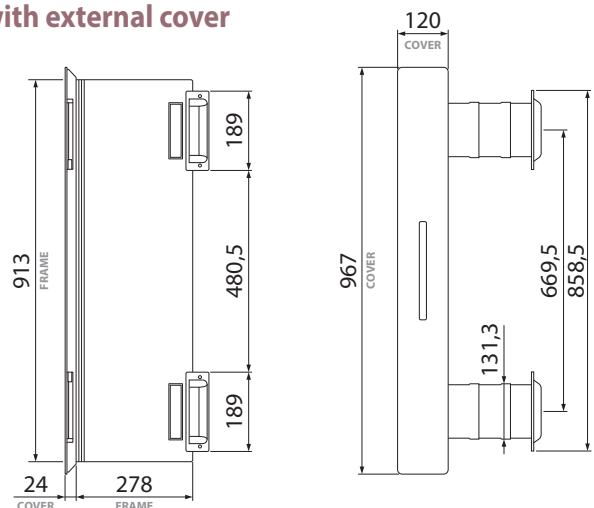

X MAX mm	SPIGOT L = 70 mm	EXTENSION L = 75 mm
48	1+1	NO
123	1+1	1+1
198	1+1	2+2
273	1+1	3+3

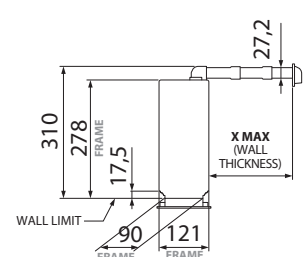

In case of wall thickness < to the measures indicated it is sufficient to cut the extensions or spigots on site.

CENTRALIZED HRU

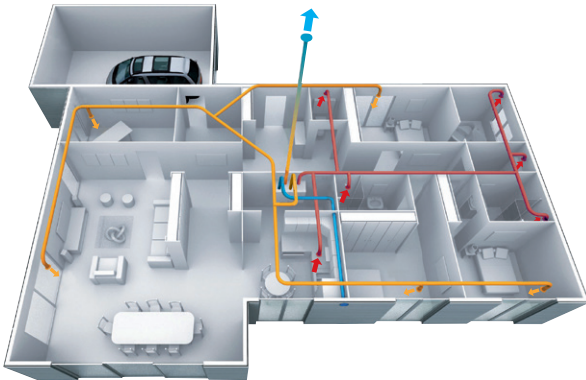

The centralized HRU is located in a technical room or in a false ceiling. The hot internal air extracted from the premises goes through a heat exchanger before being expelled outside. The fresh air coming from outside is first filtered and then goes through the exchanger where it recuperates the heat released by the extracted air.



Residential ventilation units - Horizontal installation

2 - 8 rooms



REC in line 140

Thermal efficiency **91%**
EC Brushless Motor
 Free cooling / Integrated By-pass
 Energy Class **A**

- Ideal up to 4 rooms
- Airflow up to **140 m³/h**
- Low consumption (**min. 10W**)



REC in line 180

Thermal efficiency **91%**
AC or EC Brushless Motors
 Free cooling / Integrated By-pass
 Energy Class **A (EC)**

- Ideal up to 6 rooms
- Airflow up to **180 m³/h**
- Low consumption
(min. 15W EC - min. 60W AC)

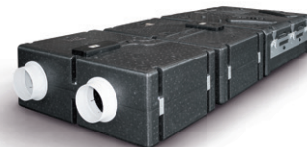

REC in line 220



Thermal efficiency **91%**
AC or EC Brushless Motors
 Free cooling / Integrated By-pass
 Energy Class **A (EC)**

- Ideal up to 8 rooms
- Airflow up to **220 m³/h**
- Low consumption
(min. 35W EC - min. 60W AC)

Residential ventilation units - Vertical installation

up to 10 rooms



REC 280



Thermal efficiency **93%**
AC motor
 Free cooling / Integrated By-pass

- Ideal up to **10 rooms**
- Airflow up to **280 m³/h**
- Low consumption (**min. 80W**)

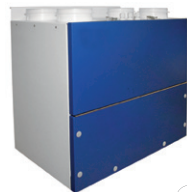

REC 320



Thermal efficiency **93%**
EC brushless motor
 Free cooling / Integrated By-pass
 Energy class **A**

- Ideal up to **10 rooms**
- Airflow up to **320 m³/h**
- Low consumption (**min. 40W**)
- **Available with Touch Panel included (TC version)**



New versions with **Touch Panel** for the weekly programming of the indoor comfort.



REC in linea

Centralized Heat Recovery Units
Horizontal installation

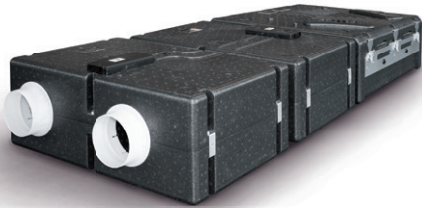

2 - 8 rooms

Complies with ErP Directive and
UE Regulation 1253/2014
Ventilation Unit (VU)

Energy class A

(EC Versions)

- Thermal efficiency up to 91%
- High energy saving thanks to EC motors
- Compact and modular
- Energy Class A (EC versions)

VERSIONS

REC in linea AC - Provided with external rotor motor and forward blade impeller 2 speed running: continuous running at the minimum speed, maximum speed is activated through remote control.

REC in linea EC - Provided with brushless motor for an optimal combination between high performance, silence and low energy consumption.

CONTROLLERS - SUPPLIED

RLS 1 WR

- Remote control
- Manual selection of three modality of continuous running:
 - I - Low ventilation modality
 - II - Intermediate ventilation modality
 - III - Intensive ventilation modality
- Supply voltage 230V - 50/60 Hz
- Weight 0,50 Kg
- Dimensions 75 x 75 x 30



Supplied with REC in linea EC 140 - 180 - 220

ACCESSORY

RLS 3V - 3 speeds

- Remote 3 speed control (Min/Max) and On/Off switch
- New design with cover
- Suitable for surface or built-in installation
- Ease of connection by the means of removable terminals
- Protection IP42
- Weight 0,40 Kg
- Supply voltage 230V - 50/60 Hz
- Dimensions 110 x 80 x 42



Accessory for AC versions of REC in linea 180

FEATURES

- High efficiency centralized heat recovery units with thermal efficiency up to 91%.
- Compact and modular.
- Horizontal installation in false ceilings.
- Lightweight and easy to install.
- Suitable for Ø125 mm ducting system.
- Made in PPE for a perfect thermal and acoustic insulation.
- Provided with integrated by-pass.
- Multispeed high efficiency EC brushless motors.
- Low sound level.
- Filters class M6 in addition to the filters assembled.
- Supplied with fixing plate, and RLS 1WR control panel (EC motor versions).
- IPX2
- Complies with EN 60335-2-80, LVD 2014/35/EU, EMC 2014/30/EU
- Performance measured by BRE according to EN 13141-7, EN 13101-4, EN 5801 and EN 308.
- CE marked

PERFORMANCE

MODEL	m ³ /h max	l/s	Pa max	V	W max	A max	dB(A)*
REC in linea 140 EC	140	39	210	230	50	0,55	24
REC in linea 180 EC	180	50	200	230	70	0,65	24
REC in linea 220 EC	220	61	340	230	106	0,90	26
REC in linea 180 AC	180	50	200	230	173	0,75	24
REC in linea 220 AC	220	61	340	230	181	0,81	26

* Lp(A) measured at 3m in open field 230V-50Hz.

MODELS

Complete range composed of 3 models for houses up to 8 rooms:

REC in linea 140



- Ideal for houses up to **4 rooms** and average surface of 80 sqm
- Installation configuration: **2 intake points and 2 extract points**
- Max airflow **140 m³/h**
- Integral by-pass
- EC motors

REC in linea 180



- Ideal for houses up to **6 rooms** and average surface of 100 sqm
- Installation configuration: **3 intake points and 3 extract points**
- Max airflow **180 m³/h**
- Integral by-pass
- AC or EC motors

REC in linea 220

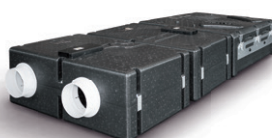

- Ideal for houses up to **8 rooms** and average surface of 120 sqm
- Installation configuration: **4 intake points and 4 extract points**
- Max airflow **220 m³/h**
- Integral or separated by-pass
- AC or EC motors





REC in linea TC

Centralized Heat Recovery Units
Horizontal installation

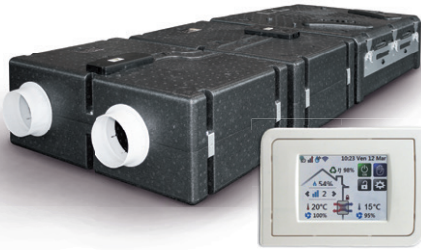

2 - 8 rooms



Complies with ErP Directive 2009/125/CE
and EU Regulation 1253/2014
Residential Ventilation Unit

Energy class A

- Thermal efficiency up to 91%
- Tested by BRE according to EN308
- Integrated by-pass
- EC motors

CONTROLLERS - SUPPLIED

RLS 1 WR

REC In Linea TC is supplied with a remote Touch Panel controller with coloured screen. The panel allows to manually or automatically activate (through the weekly programming) the following functions:

- Speed/ventilation level regulation
- Ventilation modality (by-pass function, free-cooling, only extraction, only immission)
- Threshold humidity level over which the unit increases its speed
- Post-ventilation function (Timer function, adjustable from 0 to 30 minutes) to delay the switching of the unit at the minimum speed)
- Sleep modality that allows to have the unit running silently at low speed during the night

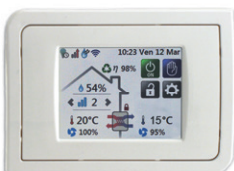

FEATURES

- High efficiency centralized heat recovery units with thermal efficiency up to 91%.
- Compact and modular.
- Horizontal installation in false ceilings.
- Lightweight and easy to install.
- Suitable for \varnothing 125 mm ducting system.
- Made in PPE for a perfect thermal and acoustic insulation.
- Provided with integrated by-pass.
- Multispeed high efficiency EC brushless motors.
- Low sound level.
- Filters class M6 in addition to the filters assembled.
- Supplied with fixing plate, and RLS 1WR control panel (EC motor versions).
- IPX2.
- Complies with EN 60335-2-80, LVD 2014/35/EU, EMC 2014/30/EU
- Performance measured by BRE according to EN 13141-7, EN 13101-4, EN 5801 and EN 308.
- marked

PERFORMANCE

MODEL	AIRFLOW MAX		PRESSURE MAX	V at 50 Hz	W max	A max	dB(A)*
	m ³ /h	l/s	Pa				
REC in linea 140 EC Plus TC	140	39	210	230	50	0,55	24
REC in linea 180 EC Plus TC	180	50	200	230	70	0,65	24
REC in linea 220 EC Plus TC	220	61	340	230	106	0,90	26

* Lp (A) measured at 3 m in open field 230V 50 Hz

MODELS

Complete range composed of 3 models for houses up to 8 rooms:

REC in linea 140 TC



- Ideal for houses up to **4 rooms** and average surface of 80 sqm.
- Installation configuration: **2 intake points and 2 extract points.**
- Max airflow **140 m³/h.**

REC in linea 180 TC



- Ideal for houses up to **6 rooms** and average surface of 100 sqm.
- Installation configuration: **3 intake points and 3 extract points.**
- Max airflow **180 m³/h.**

REC in linea 220 TC

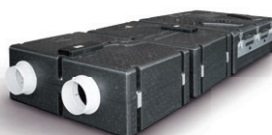

- Ideal for houses up to **8 rooms** and average surface of 120 sqm.
- Installation configuration: **4 intake points and 4 extract points.**
- Max airflow **220 m³/h.**





CURVES

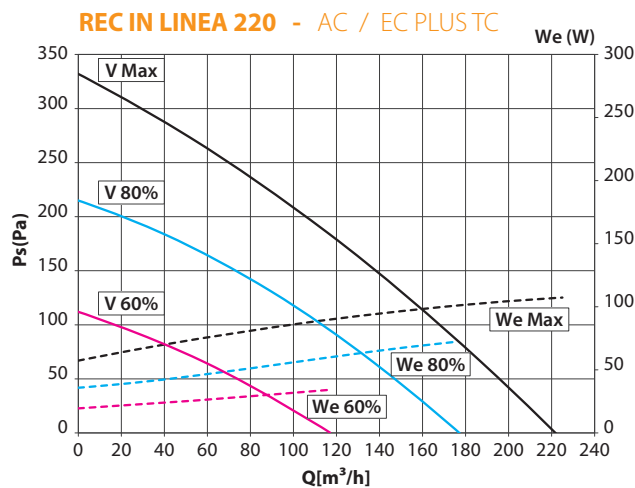
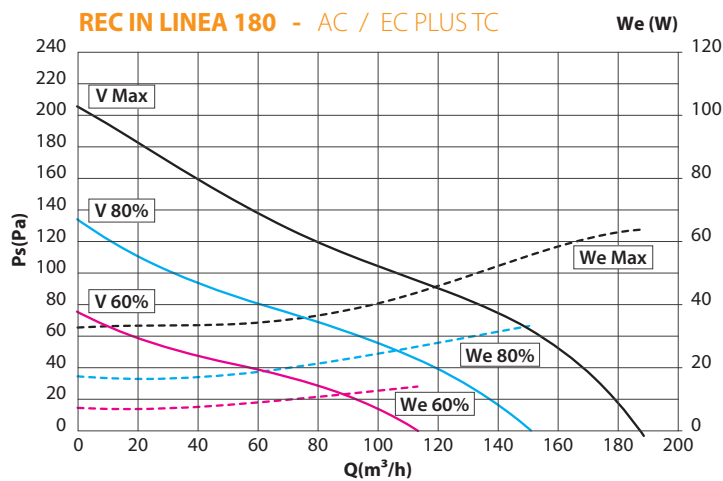
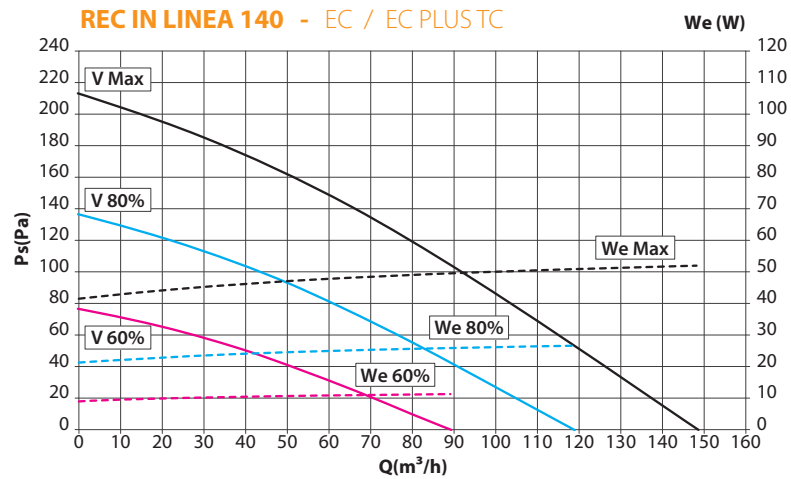



REC in linea / REC in linea TC



Centralized Heat Recovery Units
Horizontal installation

DIMENSIONS (mm)

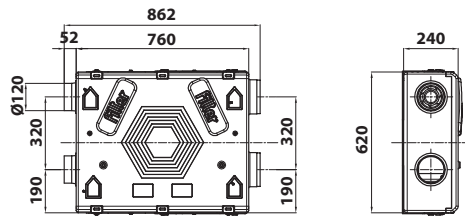

REC in linea 140
REC in linea TC 140
Kg. 13

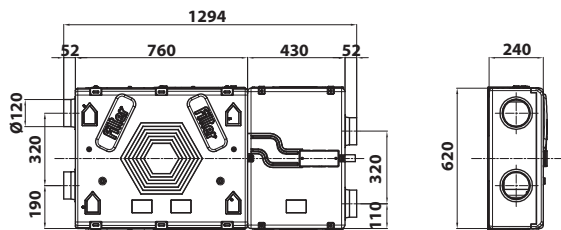
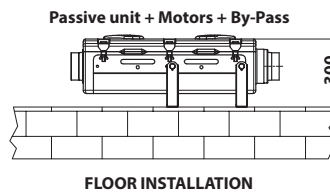
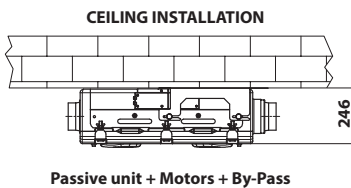

REC in linea 180
REC in linea TC 180
Kg. 18,5

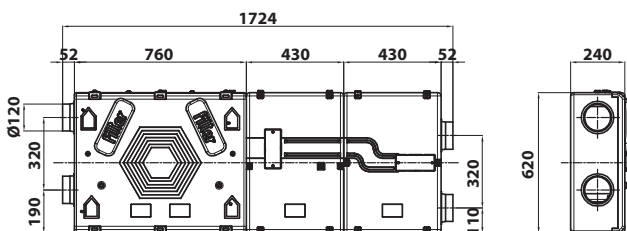
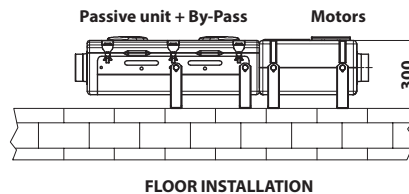
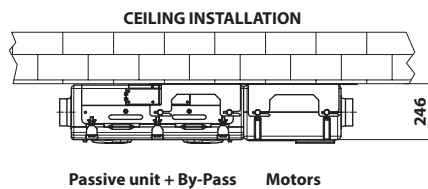

REC in linea 220
REC in linea 220 TC
Kg. 22

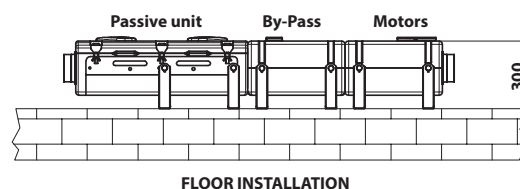
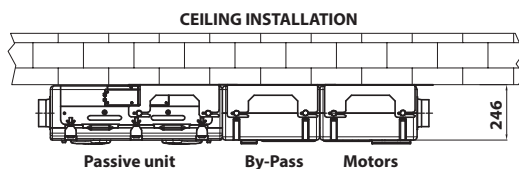



REC 280-320

Centralized Heat Recovery Units
Vertical installation



Up to 10 rooms



Complies with ErP Directive 2009/125/CE
and EU Regulation 1253/2014
Residential Ventilation Unit

Energy class A

(REC 320)

- Thermal efficiency up to **93%**
- High energy saving thanks to EC motors

FEATURES

- Centralized heat recovery unit for vertical installation.
- Suitable for \varnothing 125 mm ducting system.
- Casing made in galvanized steel sheet with epoxy finish
- Internal panels in PPE for a perfect thermal and acoustic insulation.
- Integrate or optional by-pass.
- Multispeed high efficiency motors.
- Low sound level.
- Integrated filter system class G4.
- Supplied with RLS 1WR control panel (EC motor versions).
- IPX4.
- Complies with EN 60335-2-80, LVD 2014/35/EU, EMC 2014/30/EU.
- Performance measured by BRE according to EN 13141-7, EN 13101-4, EN 5801 and EN 308.

PERFORMANCE

MODEL	m ³ /h max	l/s max	V	W max	A max	dB (A)*	Kg
REC 280 AC	280	78	230	236	1	26	27,5
REC 320 EC	320	89	230	70	1,20	26	28

* Lp(A) at 3 m in open field at the maximum aeraulic efficiency point (min. speed AC version and speed setting 60% EC version)

MODELS

REC 280 AC



- Provided with external rotor motor and forward blade impeller 2 speed running: continuous running at the minimum speed, maximum speed is activated through remote control.
- Ideal for houses up to **10 rooms**.
- Installation configuration: **5 intake points and 5 extract points**.
- Max airflow **280 m³/h**.
- High efficiency heat recovery: **93%**.
- Made in steel with epoxy finish.
- Ducting system \varnothing 125 mm.
- Integrated filter system class G4, easily removable.
- Integrated by-pass.**
- AC motor.**

REC 320 EC



- Provided with brushless motor for an optimal combination between high performance, silence and low energy consumption.
- Ideal for houses up to **10 rooms**.
- Installation configuration: **5 intake points and 5 extract points**.
- Max airflow **320 m³/h**.
- High efficiency heat recovery: **93%**.
- Made in steel with epoxy finish.
- Ducting system \varnothing 125 mm.
- Integrated filter system class G4, easily removable.
- Integrated by-pass.**
- EC motor.**



CONTROLLERS - SUPPLIED

RLS 1 WR

- Remote control
- Manual selection of three modality of continuous running:
 - I - Low ventilation modality
 - II - Intermediate ventilation modality
 - III - Intensive ventilation modality
- Supply voltage 230V - 50/60 Hz
- Weight 0,50 Kg
- Dimensions 75 x 75 x 30



Supplied with REC 320

ACCESSORY

RLS 3V - 3 speeds

- Remote 3 speed control (Min/Max) and On/Off switch
- New design with cover
- Suitable for surface or built-in installation
- Ease of connection by the means of removable terminals
- Protection IP42
- Weight 0,40 Kg
- Supply voltage 230V - 50/60 Hz
- Dimensions 110 x 80 x 42



Suitable for REC 280



REC 280-320

Centralized Heat Recovery Units
Vertical installation



CURVES

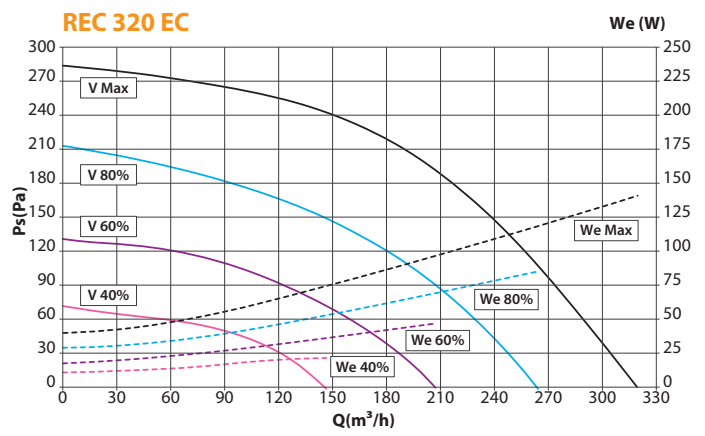
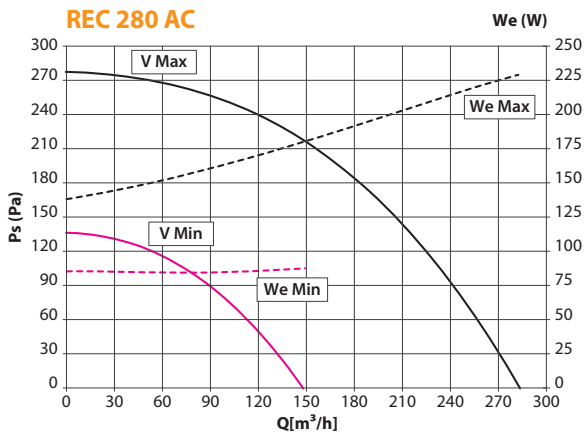

DIMENSIONS (mm)

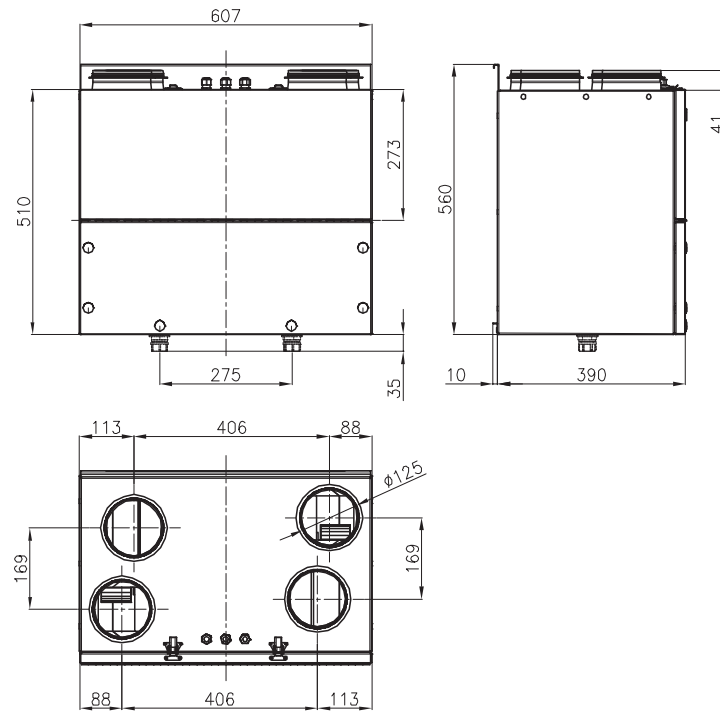

EFFICIENCY GRAPH

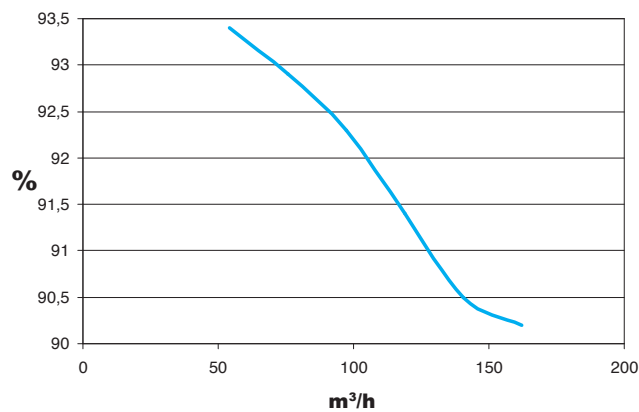



REC 320 TC

Centralized Heat Recovery Units
Vertical installation



Up to 10 rooms



Complies with ErP Directive 2009/125/CE
and EU Regulation 1253/2014
Residential Ventilation Unit

Energy class A

- Thermal efficiency up to **93%**
- Tested by BRE according to EN308
- Integrated by-pass

FEATURES

- High efficiency centralized heat recovery unit with thermal efficiency up to 93%.
- Provided with brushless motor for an optimal combination between high performance, silence and low energy consumption.
- Ideal for houses up to 10 rooms.
- Installation configuration: 5 intake points and 5 extract points.
- Max airflow 320 m³/h.
- Centralized heat recovery unit for vertical installation.
- Suitable for ø 125 mm ducting system.
- Casing made in galvanized steel sheet with epoxy finish
- Internal panels in PPE for a perfect thermal and acoustic insulation.
- Integrate or optional by-pass.
- Multispeed high efficiency motors.
- Low sound level.
- Integrated filter system class G4.
- Supplied with control panel
- IPX4.
- Complies with EN 60335-2-80, LVD 2014/35/EU, EMC 2014/30/EU
- Performance measured by BRE according to EN 13141-7, EN 13101-4, EN 5801 and EN 308.
- CE marked

PERFORMANCE

MODEL	m ³ /h max	l/s max	V	W max	A max	dB (A)*	Kg
REC 320 EC PLUS TC	320	89	230	70	1,20	26	28

* Lp(A) at 3 m in open field

CURVES

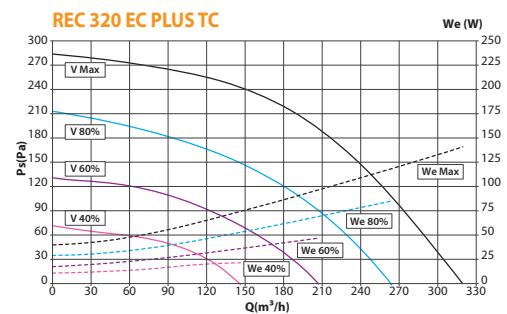

CONTROLLERS - SUPPLIED

REC 320 TC is supplied with a remote Touch Panel controller with coloured screen. The panel allows to manually or automatically activate (through the weekly programming) the following functions:

- Speed/ventilation level regulation
- Ventilation modality (by-pass function, free-cooling, only extraction, only immission)
- Threshold humidity level over which the unit increases its speed
- Post-ventilation function (Timer function, adjustable from 0 to 30 minutes) to delay the switching of the unit at the minimum speed)
- Sleep modality that allow to have the unit running silently at low speed during the night

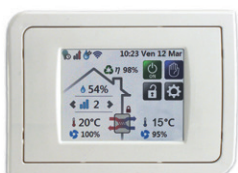

DIMENSIONS (mm)

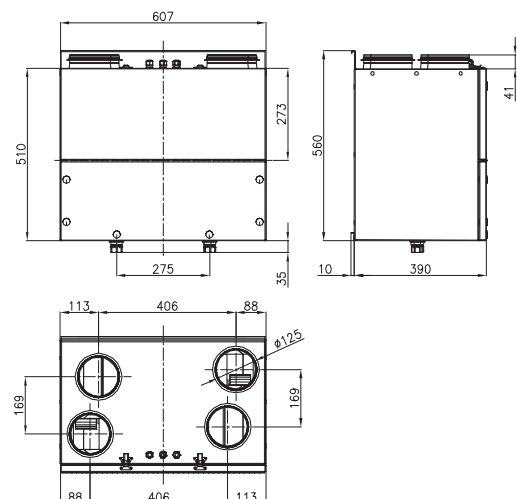

RESIDENTIAL & COMMERCIAL EXTRACT VENTILATION

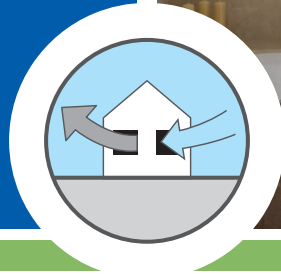

THE INDOOR AIR QUALITY PROBLEMS

Indoor Air Quality (IAQ) refers to the air quality within and around buildings and structures, especially as it relates to the health and comfort of building occupants.

Indoor pollution sources that release gases or particles into the air are the primary cause of indoor air quality problems. **Inadequate ventilation** can increase indoor pollutant levels by not bringing in enough outdoor air to dilute emissions from indoor sources and by not carrying indoor air pollutants out of the area. High temperature and humidity levels can also increase concentrations of some pollutants.

THE SOLUTION

An effective mechanical extract ventilation is essential for a clean and healthy living environment, especially in:

- Public toilets
- Home toilets and bathrooms
- Kitchens
- Laundries

Our fans range include centralized and decentralized solutions suitable for any installation requirement.

CENTRALIZED MULTIPOINT EXTRACT VENTILATION

Wholehouse extract ventilation

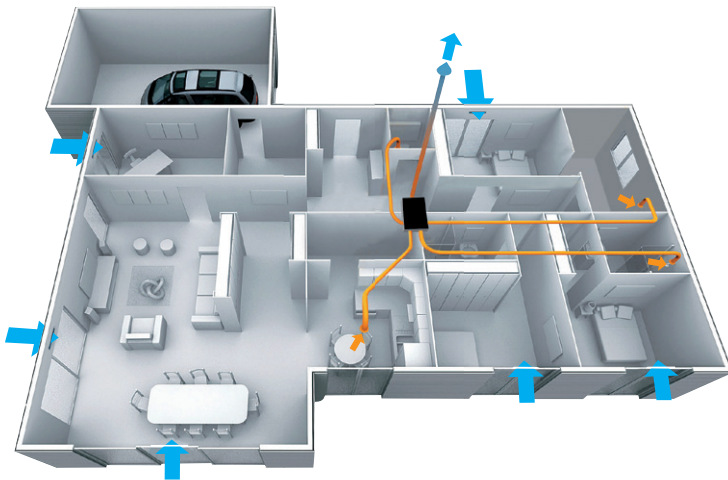

High efficiency central ventilation solutions for air extract: the stale air is exhausted from humid rooms (kitchen, bathroom, toilets, laundry). The fresh air is supplied by specific air entrance points.

- High energy efficiency with EC motors.
- Designed for ease of installation and low noise running
- All models available with EC motors 



MICROBOX

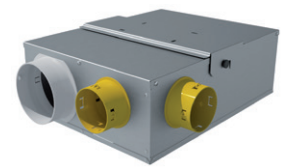

MULTIBOX

Multipoint extract ventilation

OUTDOOR installation

EXT

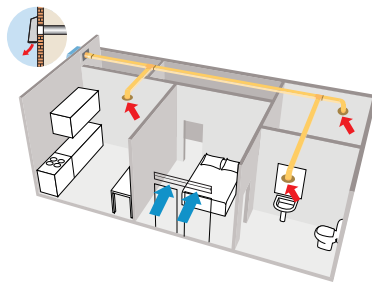

MRF

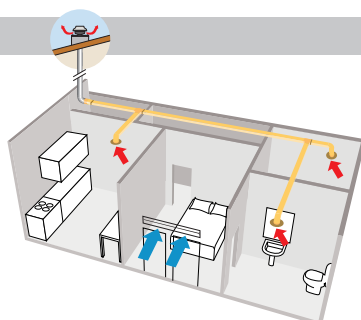
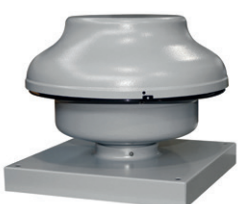

IN-LINE installation

AXC

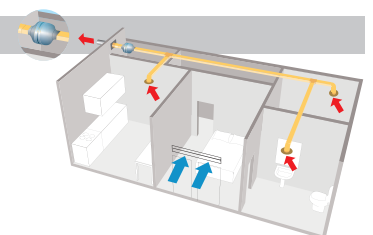

AXC TP

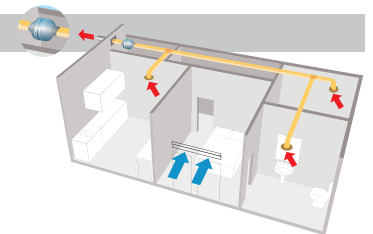

AXM





MICROBOX

Whole-house mechanical extract ventilation
Super-slim centrifugal box

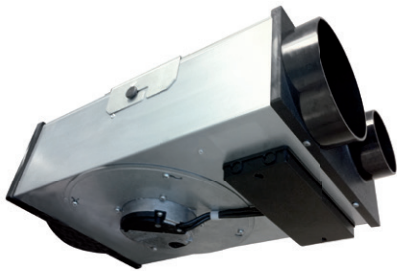

Complies with ErP Directive and
UE Regulation 1253/2014
Ventilation Unit (VU)

- High energy saving
- SUPER-SLIM
- Extreme ease of installation and maintenance
- Silent operation thanks to acoustic insulation lining



PERFORMANCE

MODELS	CONFIGURATION	MOTOR	m³/h	l/s	W	A	dB(A)*
			max	max	max	max	max
MICROBOX Control HY	80 / 125	AC	246	68	49	0,22	41
MICROBOX Control AQS	80 / 125	AC	246	68	49	0,22	41
MICROBOX Control HY	3x 80 / 125	AC	246	68	49	0,22	41
MICROBOX Control AQS	3x 80 / 125	AC	246	68	49	0,22	41
MICROBOX Control HY EC	80 / 125	EC	360	100	86	0,78	45
MICROBOX Control AQS EC	80 / 125	EC	360	100	86	0,78	45
MICROBOX Control HY EC	3x 80 / 125	EC	360	100	86	0,78	45
MICROBOX Control AQS EC	3x 80 / 125	EC	360	100	86	0,78	45

* Lp(A) measured at 3 m in open field 230V-50Hz

DIMENSIONS (mm)

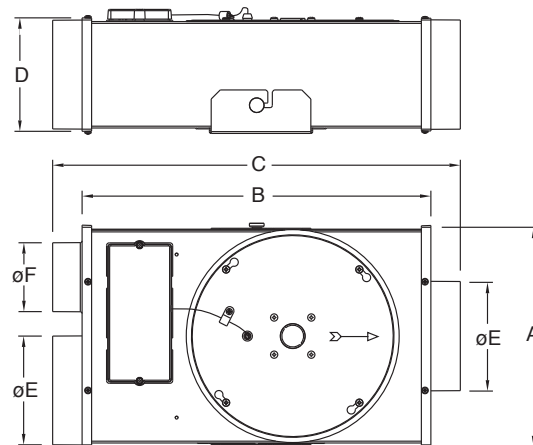

TYPE	A	B	C	D	ØE	ØF	Kg
MICROBOX	241	384	448	135	125	80	5,8

CONTROL PANEL



CP-RH
Supplied with
Microbox Control
HY AC and EC



CP-AQS
Supplied with
Microbox Control
AQS AC and EC

CHARACTERISTICS

Control panel:

Measures a set of (control) parameters representative of the ventilation demand / quality of the indoor air.

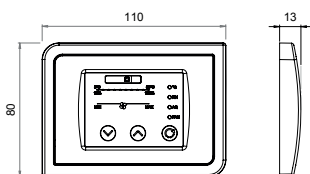

FUNCTION	CP-RH	CP-AQS
Temperature control	●	●
Relative humidity detection	●	●
Air quality control		●
Continuous Speed Regulation	●	●

INSTALLATION

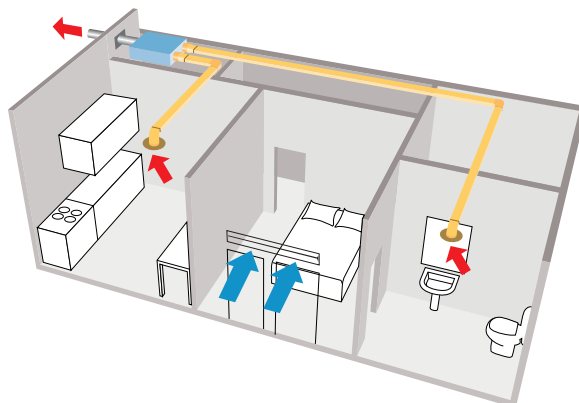



MULTIBOX

Whole-house mechanical extract ventilation
Multiport centrifugal box

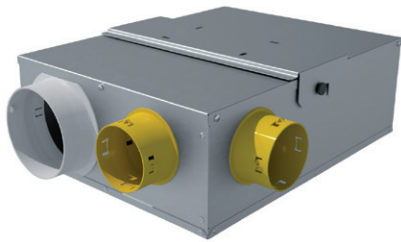

Complies with ErP Directive and
UE Regulation 1253/2014
Ventilation Unit (VU)

- High energy saving
- Silent operation
- Extreme ease of installation and maintenance
- Silent operation



PERFORMANCE

MODELS	CONFIGURATION	MOTOR	m³/h	l/s	W	A	dB(A)*
			max	max	max	max	max
MULTIBOX Control HY	3x 80 / 125	AC	348	97	47,5	0,21	35
MULTIBOX Control AQS	3x 80 / 125	AC	348	97	47,5	0,21	35
MULTIBOX Control HY	3x 80 / 125	EC	490	136	95	0,77	37
MULTIBOX Control AQS	3x 80 / 125	EC	490	136	95	0,77	37

* Lp(A) measured at 3 m in open field 230V-50Hz

DIMENSIONS (mm)

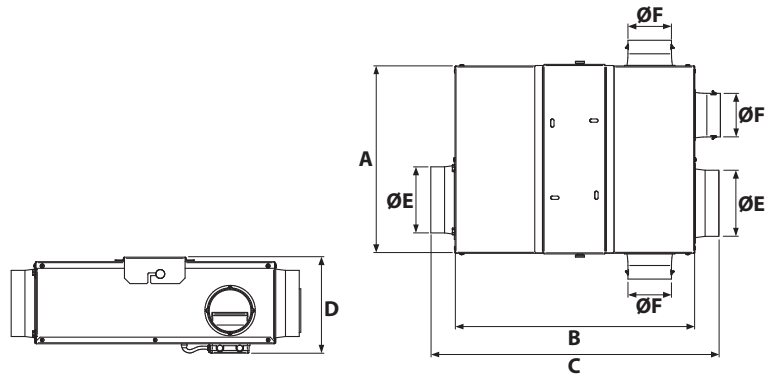

TYPE	A	B	C	D	ØE	ØF	Kg
MULTIBOX	345	437	523	174	125	80	6,2

CONTROL PANEL



CP-RH
Supplied with
Multibox Control
HY AC and EC



CP-AQS
Supplied with
Multibox Control
AQS AC and EC

CHARACTERISTICS

Control panel:

Measures a set of (control) parameters representative of the ventilation demand / quality of the indoor air.

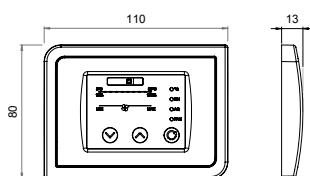

FUNCTION	CP-RH	CP-AQS
Temperature control	●	●
Relative humidity detection	●	●
Air quality control		●
Continuous Speed Regulation	●	●

INSTALLATION

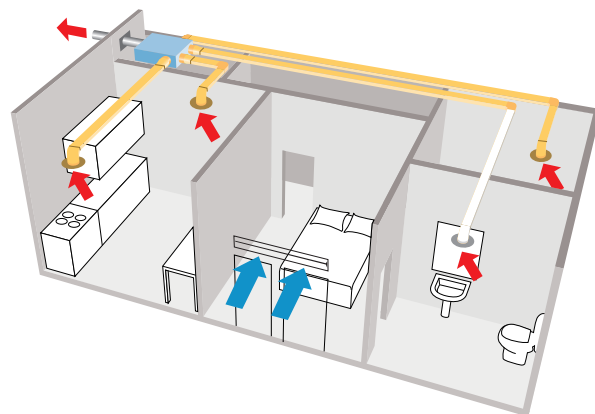



EXT

Centrifugal fans
for outdoor installation



Complies with ErP Directive 2009/125/CE
and UE Regulation 1253/2014
Residential Ventilation Unit



PERFORMANCE

MODELS	m ³ /h	l/s	Pa	W	A	dB(A)*
EXT 100	217	60	268	28	0,13	44
EXT 125	269	75	259	28	0,13	44
EXT 150 A (1)	426	118	322	56	0,24	56
EXT 150 B (1)	708	197	467	110	0,48	59
EXT 160 A (1)	433	120	309	56	0,24	56
EXT 160 B (1)	755	210	480	120	0,53	61
EXT 200 A (1)	793	220	486	120	0,53	61
EXT 200 B (1)	908	252	609	158	0,70	65

* LpA measured at 3m in open field 230V-50Hz.

(1) To comply with the ErP2018 parameters, a local demand controller must be used. See E-VSD pag. 99.

- High performance centrifugal fans for outdoor installation
- Ideal in environments where aesthetics, space or noise level are of concern
- Easy and cost-effective solution for a centralized ventilation requirement
- 8 models Ø100 to 200 mm
- Steel housing with epoxy finish
- Ball bearing motor. Backward curved blades
- EC Version available (See pag. 73)

CURVES

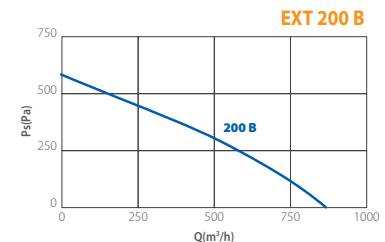
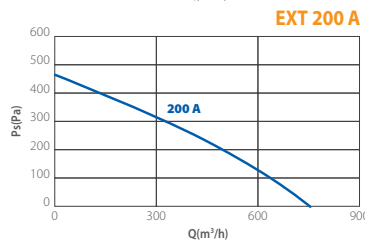
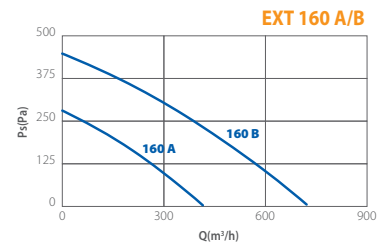
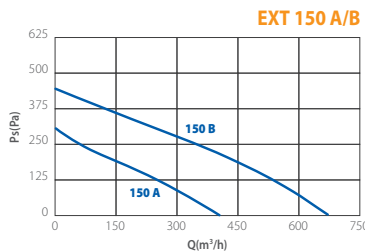
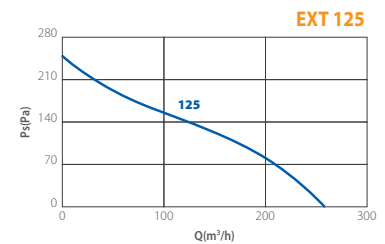
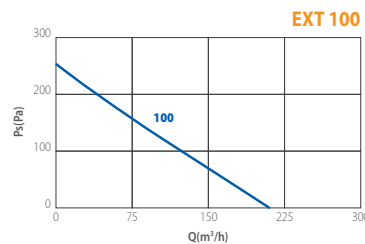

DIMENSIONS (mm)

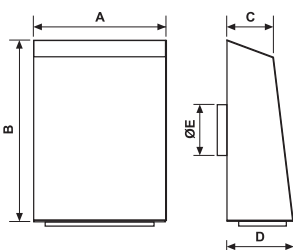

MODELS	A	B	C	D	ØE	Kg
EXT 100	260	355	92	131	98	4,8
EXT 125	260	355	92	131	122	4,8
EXT 150 A	260	355	92	131	148	5
EXT 150 B	360	450	116	155	148	7,4
EXT 160 A	260	355	92	131	158	5
EXT 160 B	360	450	116	155	157	7,4
EXT 200 A/B	360	450	116	155	198	7,4

INSTALLATION

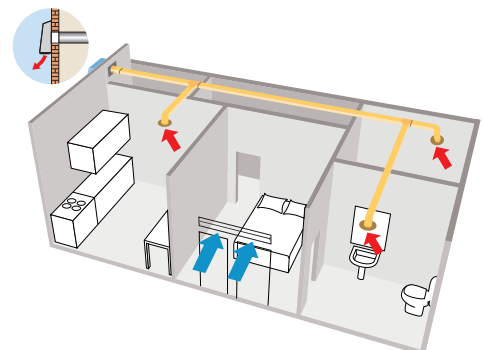

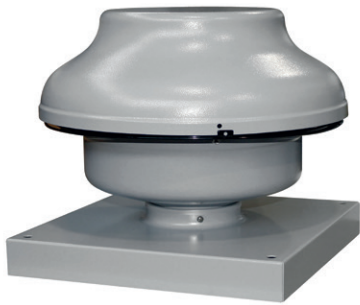

Complies with ErP Directive 2009/125/CE and UE Regulation 1253/2014 Residential Ventilation Unit



PERFORMANCE

MODELS	m³/h	l/s	Pa	W	A	dB(A)*
MRF 100 (I)	318	88	415	50	0,22	52
MRF 125 (I)	342	95	395	50	0,22	52
MRF 150 (I)	579	161	459	85	0,37	52
MRF 160 (I)	736	204	515	108	0,47	54
MRF 200 (I)	794	280	503	110	0,48	55
MRF 250 (I)	866	240	602	148	0,65	55
MRF 315 (I)	1222	339	838	247	1,10	55

* LpA measured at 3m in open field 230V-50Hz
(1) To comply with the ErP2018 parameters, a local demand controller must be used. See E-VSD pag. 99.

- High performance centrifugal fans for roof installation.
- Compact sizes, available with or without square roof curb.
- Easy and cost-effective solution for a centralized ventilation requirement.
- 7 models Ø100 to 315 mm.
- Made in aluminium and steel sheet with epoxy finish, highly resistant to atmospheric agents.
- Ball bearing motor.
- EC Version available (See pag. 74).

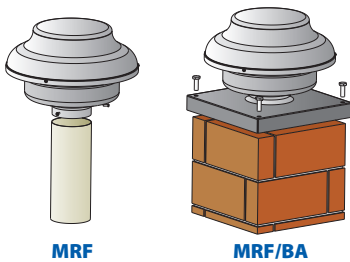

MODELS

- MRF
- MRF-BA with square roof curb

CURVES

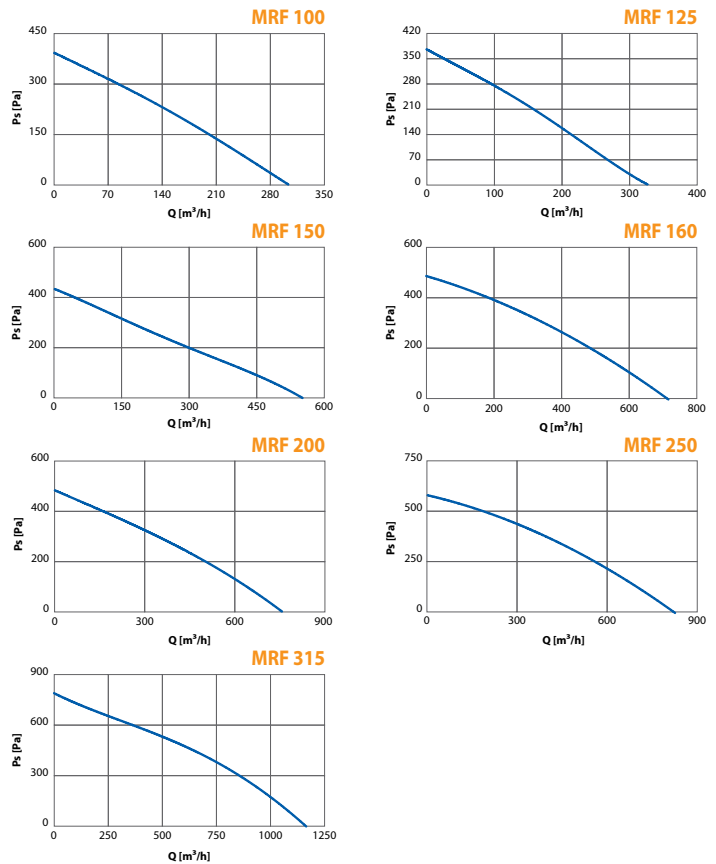

INSTALLATION

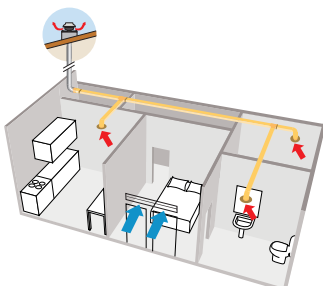

DIMENSIONS (mm)

MODELS	D1	D2	H	∅ A	∅ B	C	Kg	Kg*
MRF100	98	333	225	300	265	36	3	4,5
MRF125	122	333	225	300	265	36	3	4,5
MRF150	147	405	266	400	360	36	5	7,5
MRF160	157	405	266	400	360	36	5	7,5
MRF200	198	405	266	400	360	36	5	7,5
MRF250	248	405	266	400	360	36	5	7,5
MRF315	314	484	322	400	360	36	8	10

* Models with square roof curb

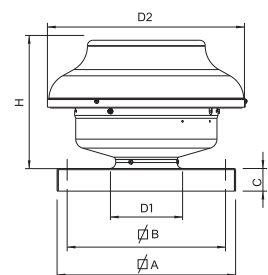



AXC

Centrifugal in-line duct fans
Metal Version



Complies with ErP Directive 2009/125/CE and UE Regulation 1253/2014

AXC 100 - 200 / Residential Ventilation Unit
AXC 250 - 315 / Non Residential Ventilation Unit



PERFORMANCE

MODELS	m ³ /h	l/s	Pa	W	A	dB(A)*
AXC 100 A	237	66	279	27	0,13	30
AXC 100 B (1)	260	72	383	50	0,23	36
AXC 125 A	287	80	238	27	0,13	32
AXC 125 B (1)	313	87	345	50	0,23	36
AXC 150 A	337	94	189	29	0,14	33
AXC 150 B (1)	537	149	406	80	0,37	39
AXC 160 A	365	101	203	29	0,14	31
AXC 160 B (1)	754	209	476	110	0,50	38
AXC 200 (1)	887	246	460	110	0,50	34
AXC 250	1114	309	543	150	0,65	43
AXC 315	1439	400	742	260	1,14	43

* LpA measured at 3m in open field 230V-50Hz.

(1) To comply with the ErP2018 parameters, a local demand controller must be used. See E-VSD pag. 99.

- High performance centrifugal fans for in-line duct installation.
- Easy and cost-effective solution for a centralized ventilation requirement.
- 11 models Ø100 to 315 mm.
- Steel housing with epoxy finish inside and outside.
- Ball-bearing motor. Backward curved blades.
- Impeller in tecnopolymer up to size 250 - Metal on size 315-315.
- T max 25°C for model AXC 315 230V - 60Hz
- EC Version available (See pag. 75)

SUPPLIED

Wall fixing brackets



CURVES

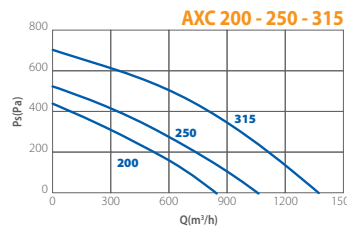
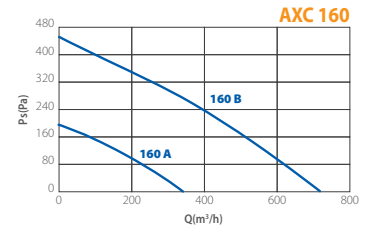
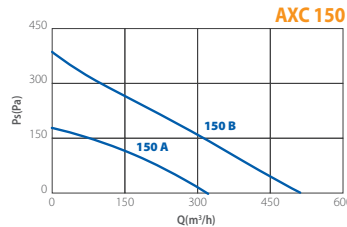
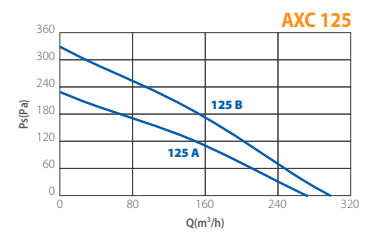
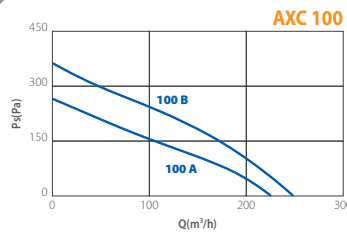

INSTALLATION

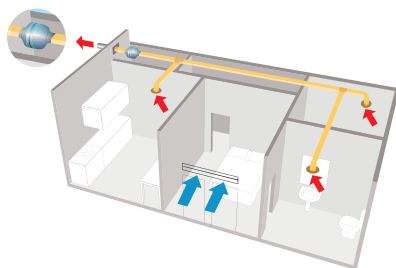

DIMENSIONS (mm)

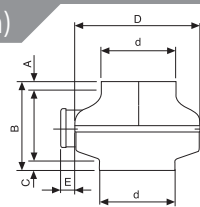

MODELS	A	B	C	ØD	Ød	E	Kg
AXC 100 A	12	215	24	245	98	38	3
AXC 100 B	12	215	24	245	98	38	3
AXC 125 A	11	214	24	245	122	38	3
AXC 125 B	11	214	24	245	122	38	3
AXC 150 A	21	216	23	245	147	38	3
AXC 150 B	22	230	22	333	148	38	5
AXC 160 A	24	215	24	245	157	38	3
AXC 160 B	21	230	22	333	158	38	5
AXC 200	22	230	27	333	198	38	5
AXC 250	22	230	35	333	248	38	5
AXC 315	30	297	52	404	314	38	8

INSTALLATION

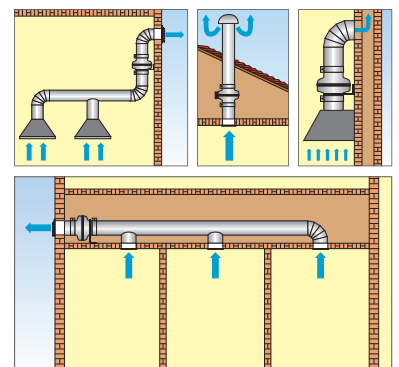



AXC TP

Centrifugal in line duct fans
TP Version



Complies with ErP Directive 2009/125/CE
and EU Regulation 1253/2014
Classification: Residential Ventilation Unit

- Lightweight and silent
- Made of self-extinguishing V2 technopolymer
- Backward curved blades and ball bearing motor provided with thermal cut-out
- 4 models with Ø from 100 to 160 mm



PERFORMANCE

MODELS	DUCT Ø mm	m³/h	l/s	Pa	A	W	dB (A)*
AXC 100 TP	100	211	58	263	0,13	27	32
AXC 125 TP	125	265	73	251	0,13	27	33
AXC 150 TP (1)	150	430	119	325	0,29	65	39
AXC 160 TP (1)	160	450	125	325	0,29	65	40

* LpA measured at 3m in open field 230V-50Hz.
(1) To comply with the ErP2018 parameters, a local demand controller must be used. See E-VSD pag. XX.

DIMENSIONS (mm)

MODELS	A	B	ØC	ØD	Kg.
AXC 100 TP	238	25	98	212	1,5
AXC 125 TP	238	25	123	212	1,5
AXC 150 TP	232	28	147	253	2
AXC 160 TP	232	28	157	253	2

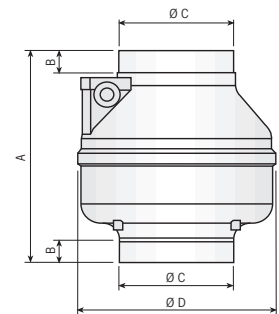

CURVES

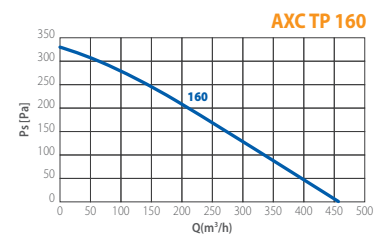
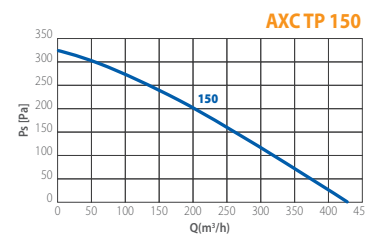
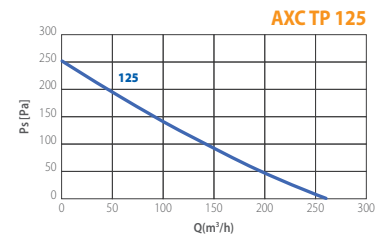
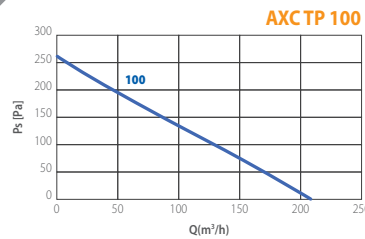

INSTALLATION

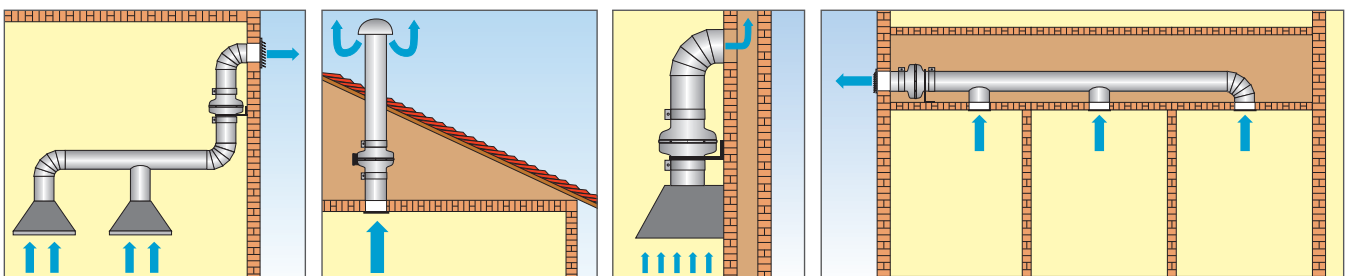



Complies with ErP Directive 2009/125/CE and EU Regulation 327/2011
Classification FAN



PERFORMANCE

MODELS	m³/h	l/s	W	A	dB(A)* at 3 m	
					Lw	Lp
AXM 100	160 / 250	44 / 69	35	0,1 / 0,18	55	39
AXM 125	180 / 300	50 / 83	36	0,1 / 0,18	54	44
AXM 150	340 / 480	94 / 133	70	0,27 / 0,36	66	50
AXM 160	340 / 480	94 / 133	70	0,27 / 0,36	65	50
AXM 200	720 / 820 / 910	200 / 228 / 253	75	0,24 / 0,27 / 0,34	58	43

* Lp(A) measured at 3m in open field 230V-50Hz

- Duct fans, entirely made of polypropylene
- For direct installation between ducts
- Easy inspection and maintenance by simply opening the clamp and removing the fan
- Helicentrifugal mixed flow impeller with downstream stator. Made in ABS
- Asynchronous motor, 2 and 3 speeds, depending on model
- IP 44 Protection, Motor Class B
- Robust motor with ball bearings, maintenance-free
- 220 - 240 V at 50 Hz
- Speed control using phase control or transformer (exception: Version with timer)
- Thermal overload protection as a standard feature
- Externally fitted terminal box with cable entry grommet

BENEFITS

- High efficiency resulting in minimum energy costs.
- Quiet running thanks to optimized aerodynamics and guide vanes.
- Easy installation: pre-installed mounting brackets and external connection box.
- Simplified maintenance by loosening the clamps (no need to handle the duct).
- Versatile installation.

VERSIONS



TIMER





AXM 100

DIMENSIONS (mm)

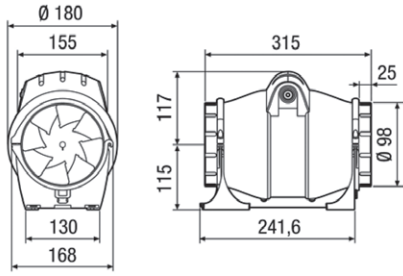

Kg. 2,1

CURVES

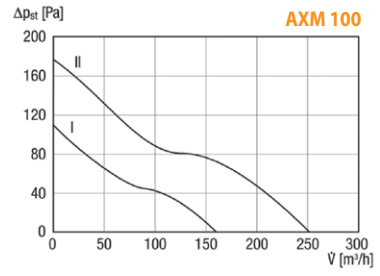

AXM 125

DIMENSIONS (mm)

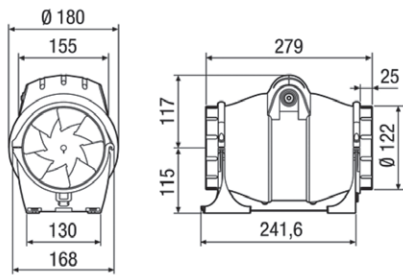

Kg. 2,1

CURVES

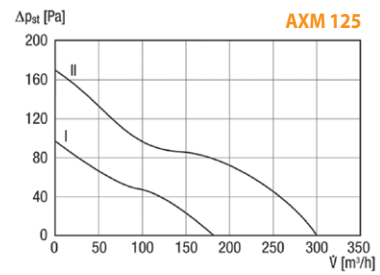

AXM 150

DIMENSIONS (mm)

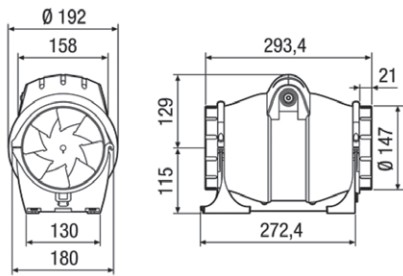

Kg. 3,2

CURVES

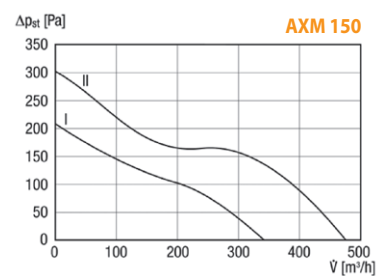

AXM 160

DIMENSIONS (mm)

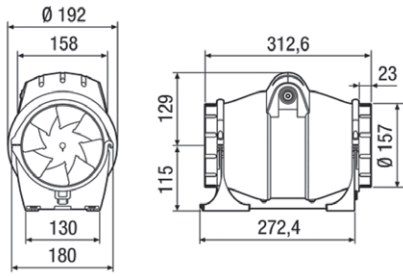

Kg. 3,2

CURVES

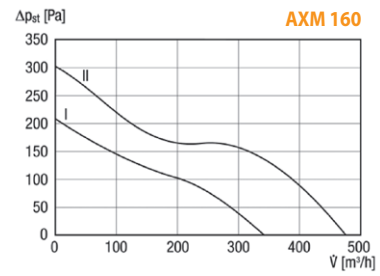

AXM 200

DIMENSIONS (mm)

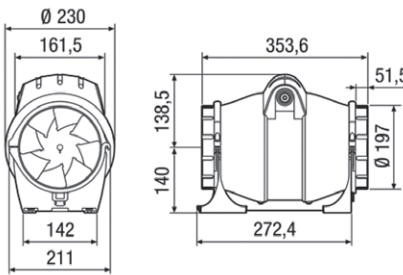

Kg. 4,5

CURVES

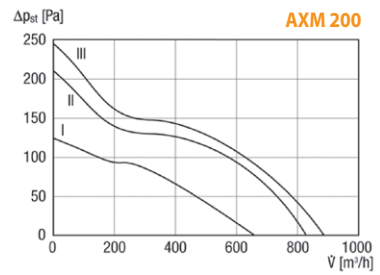

DECENTRALIZED EXTRACT VENTILATION



AXIAL FANS

Axial fans are designed to extract large volumes of low pressure air directly to the outside or over short duct lengths. They can be suitable for wall, window, duct and ceiling application.

Wall and ceiling installation

E-SMILE

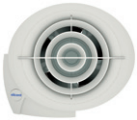

ELEGANCE



E-STYLE



ECO LINE



MURO



TUBO

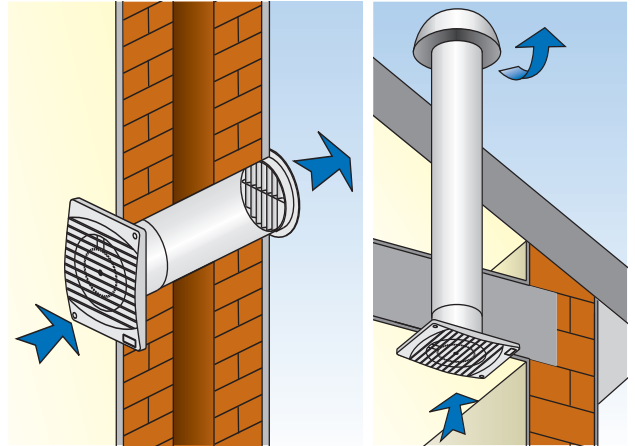

Wall installation

BUILT-IN

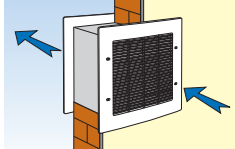

JOLLY

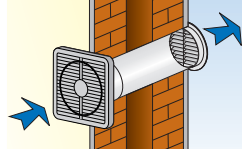

MINISTYLE

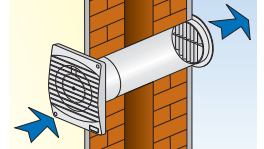

Window installation

VITRO

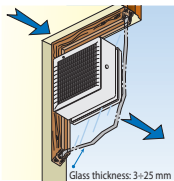

WINDOW

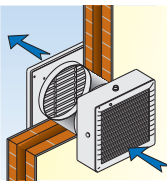

WALL

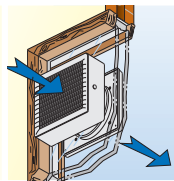

DOUBLE GLASS

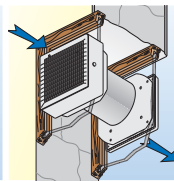

DOUBLE WINDOW

ECOWIND

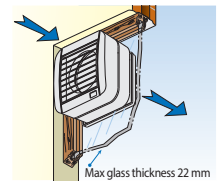

Max glass thickness 22 mm



CENTRIFUGAL FANS

Centrifugal fans are designed to extract air over long distances and to overcome the resistance of long length and curved ducting. They are suitable for wall, ceiling, roof installation, in single or multiple ducts.

Duct installation

ELIX



ELPREX



FLUX



RADIA

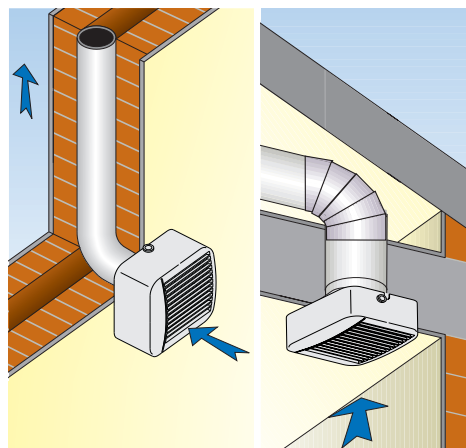

Outdoor installation

TIRAFUMO

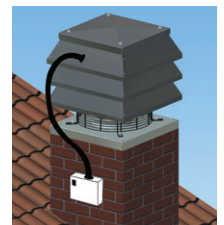



E-SMILE

Powerflow Low Watt wall axial fans
Wall and ceiling installation



Complies with ErP Directive 2009/125/CE
and EU Regulation 1253/2014
Classification: Residential Ventilation Unit

- To exhaust air directly to the outside or into medium length ducting (max 3 m length).
- Suitable for toilets, bathrooms, WC's, shower-rooms, utility rooms and kitchens.
- Unique model ø100 mm
- High aeraulic performance
- Low consumption: from 5 to 7,5 W
- Provided with ball bearing motor Long Life 30.000 hours and robust back-draught shutters

PERFORMANCE

MODELS	m ³ /h	l/s	Pa	W	dB(A)*
E-SMILE	90	25	71	7,5	29,4
E-SMILE COMFORTIMER	90 / 60	25 / 17	71 / 44	7,5 / 5	29,4 / 19
E-SMILE COMFORT HYGRO	90 / 60	25 / 17	71 / 44	7,5 / 5	29,4 / 19
E-SMILE PIR	90	25	71	7,5	29,4
E-SMILE SELV	90	25	71	7,5	29,4

* Lp(A) measured at 3m in open field 230V-50Hz.

CURVES

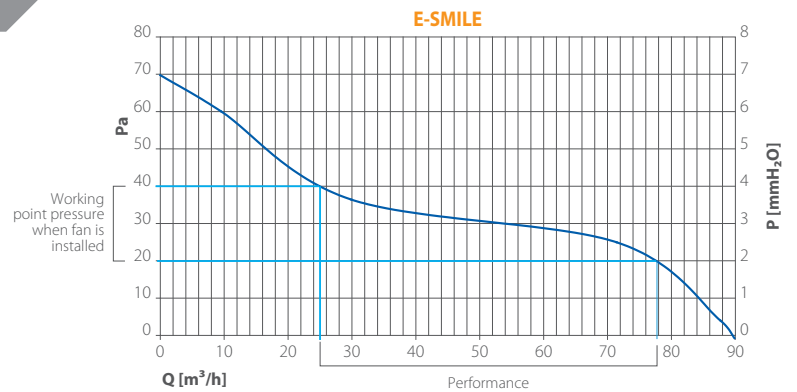

VERSIONS

- BASE** - On/off through light or remote control switch
- TIMER** - Integral electronic timer adjustable from 3 to 25 minutes
- CMT - COMFORTIMER** - Overrun timer at low speed
- MHT** - Humidity control, adjustable from 40 to 80% of R.H. and Timer adjustable from 3 to 25 mm
- MHY** - Smart Humidity control automatic progressive increase/decrease of fan speed according to the percentage of Relative Humidity
- PIR** - On/off via Passive infrared sensor
- 2V** - 24 hours running at the lowest speed
- SELV** SELV 12 V - SELV 12 V a.c.

INSTALLATION

CEILING

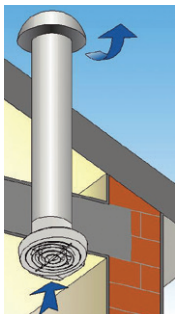

SINGLE DUCT

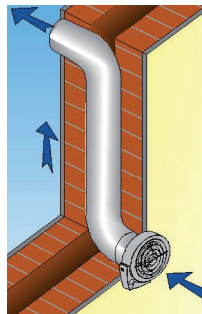

WALL

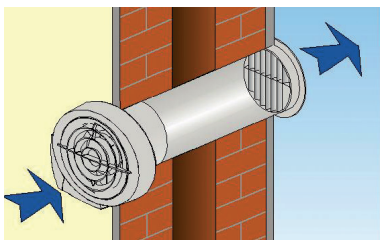

DIMENSIONS (mm)

MODEL	A	B	C	D	EØ	Kg
E-SMILE	168	150	57	45	99,8	0,67

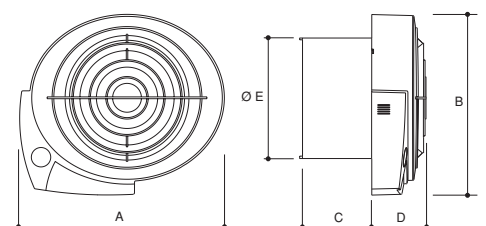



ELEGANCE

Wall and ceiling axial fans
Linea Design



Complies with ErP Directive 2009/125/CE and EU Regulation 1253/2014
Classification: Residential Ventilation Unit

- To exhaust air directly to the outside or into a short length ducting (max 3 m length).
- Suitable for toilets, bathrooms, WC's, shower-rooms, utility rooms and kitchens.
- Innovative design with flat cover and lateral intake.
- Provided with ball bearing motor long Life 30.000 hours and backdraught shutters.
- Advanced profile which optimizes the fluid dynamic performance of the fan.

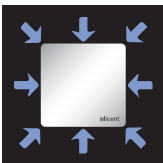

Lateral intake on the whole perimeter

INSTALLATION

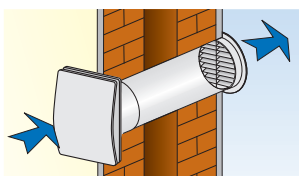

WALL

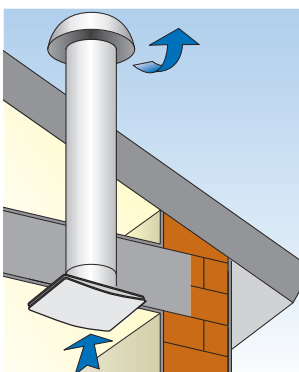

CEILING



PERFORMANCE

MODELS	PROTECTION	m ³ /h	l/s	Pa	W	dB(A)*
Base - Timer - Pull cord - MHY smart						
ELEGANCE 100	IPX4	90	25	41	14	31,4
ELEGANCE 120	IPX4	165	46	54	15	36,7
ELEGANCE 150	IPX4	315	87	70	25	43,9
Comfortimer - 2 V						
ELEGANCE 100	IPX4	90 / 58	25 / 16	41 / 20	14 / 6	31,4 / 27,4
ELEGANCE 120	IPX4	165 / 103	46 / 29	54 / 20	15 / 8	36,7 / 28,4
ELEGANCE 150	IPX4	315 / 182	87 / 50	70 / 15	25 / 13	43,9 / 29,5

* Lp(A) measured at 3m in open field 230V-50Hz.

VERSIONS



BASE - On/off through light or remote control switch



PULL CORD - On/off through pull cord switch



TIMER - Integral electronic timer adjustable from 3 to 25 minutes



CMT - COMFORTIMER - Overrun timer at low speed



MHY - Smart Humidity control automatic progressive increase/decrease of fan speed according to the percentage of R.H.



2V - 24 hours running at the lowest speed



EC VERSIONS - See pag. 71

DIMENSIONS (mm)

MODELS	A	ØB	C	D	Kg
ELEGANCE 100	160	98	80	38	0,9
ELEGANCE 120	180	119	91	44	1,1
ELEGANCE 150	200	149	105	56	1,3

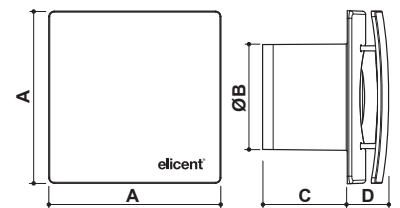

CURVES

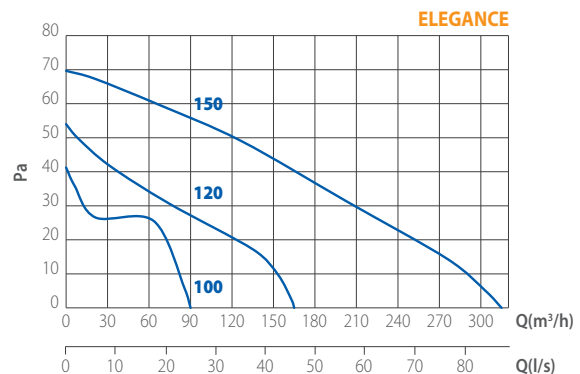



Complies with ErP Directive 2009/125/CE and EU Regulation 1253/2014
Classification: Residential Ventilation Unit



PERFORMANCE

MODELS	m ³ /h	l/s	Pa	W	dB (A)*
E-STYLE 90	80	22	23	10	30,1
E-STYLE 100	95	26	42	14	31,4
E-STYLE 120	165	46	55	15	36,7
E-STYLE 150	315	87	71	25	43,9

* Lp(A) measured at 3m in open field 230V-50Hz.

CURVES

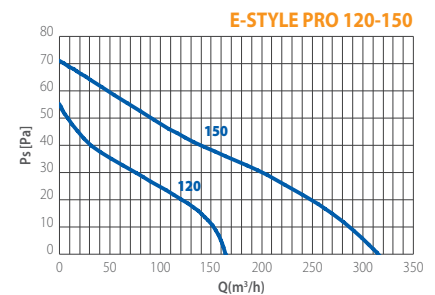
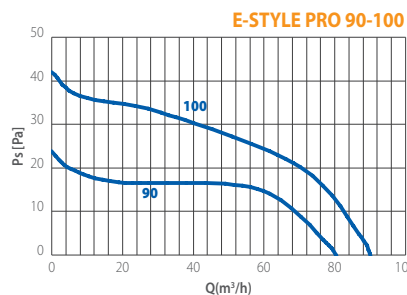

ULTRA SLIM

17 mm

- To exhaust air directly to the outside or into a short length ducting (max 3 m length).
- Suitable for toilets, bathrooms, WC's, shower-rooms, utility rooms and kitchens.
- Provided with back draught shutters on models 100, 120, 150
- Neon running light
- Style, technology

VERSIONS



BASE - On/off through light or remote control switch.



TIMER - Integral electronic timer adjustable from 3 to 25 minutes.



MHT - Humidity control, adjustable from 40 to 80% of R.H. and Timer adjustable from 3 to 25 min.



MHY - Smart Humidity control automatic progressive increase/decrease of fan speed according to the percentage of R.H.



SELV - SELV 12 V a.c. (for size 100 only)

INSTALLATION

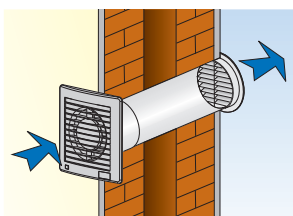

WALL

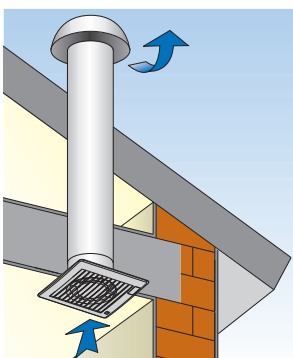

CEILING

DIMENSIONS (mm)

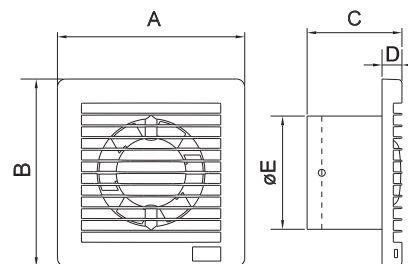

MODELS	A	B	C	D	EØ	Kg
E-STYLE 90	160	160	81	17	92	0,4
E-STYLE 100	160	160	95	17	98	0,4
E-STYLE 120	180	180	101	18	119	0,6
E-STYLE 150	200	200	119	22	149	1,0

ACCESSORY

CHROME



INOX SATIN



Upon request and according to minimum batches



Complies with ErP Directive 2009/125/CE and EU Regulation 1253/2014
Classification: Residential Ventilation Unit



FEATURES

P.I.R. MODEL with passive infrared sensor

- Available in 3 sizes: Ø100, 120 and 150
- Provided with integral timer, adjustable from 3 to 25 mn
- Ideal for public premises
- Quick and easy installation as it is not necessary to install a control switch
- Completely automatic running

PERFORMANCE

MODELS	m ³ /h	l/s	Pa	W	dB (A)*
E-STYLE 100 P.I.R.	90	25	42	14	31,4
E-STYLE 120 P.I.R.	165	46	55	15	36,7
E-STYLE 150 P.I.R.	315	87	71	25	43,9

* Sound pressure at 3 mt

INSTALLATION



DETECTION SPECTRUM

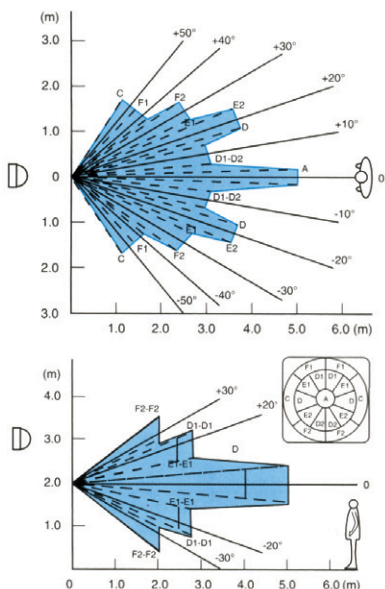

DIMENSIONS (mm)

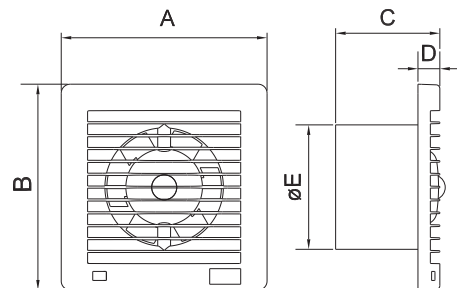

MODEL	A	B	C	D	ØE	Kg
E-STYLE 100 P.I.R.	160	160	95	17	98	0,4
E-STYLE 120 P.I.R.	180	180	101	18	119	0,6
E-STYLE 150 P.I.R.	200	200	119	22	149	1,0

CURVES

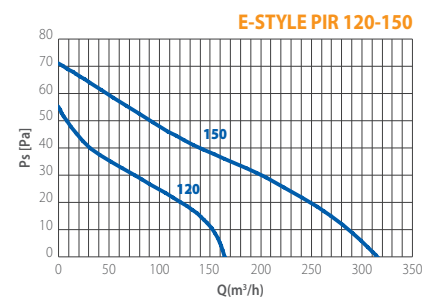
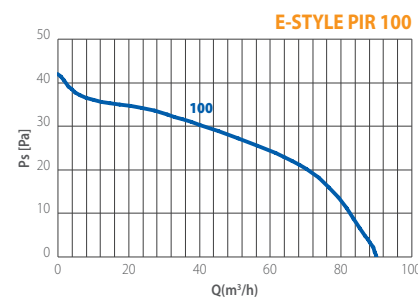



Slim wall axial fans
Ultra slim style



Complies with ErP Directive 2009/125/CE and EU Regulation 1253/2014
Classification: Residential Ventilation Unit



PERFORMANCE

MODELS	PROTECTION	m ³ /h	l/s	Pa	W	dB(A)*
E-Style 100 TREND	IPX4	85	24	32	12	26,4
E-Style 120 TREND	IPX4	165	46	54	15	36,7
E-Style 150 TREND	IPX4	295	82	71	25	43,9

* Lp(A) measured at 3m in open field 230V-50Hz.

CURVES

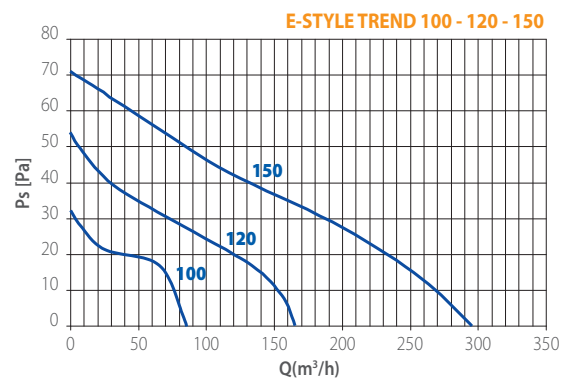

- To exhaust air directly to the outside or into a short length ducting (max 3 m length).
- Suitable for toilets, bathrooms, WC's, shower-rooms, utility rooms and kitchens.
- Basic version of e-style pro (no neon running light - back draught shutters upon request)
- Complete range and high aeraulic performances.
- Back drought shutter upon request.

DIMENSIONS (mm)

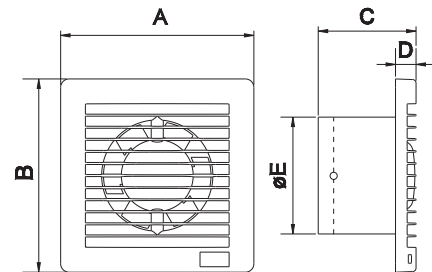

MODELS	A	B	C	D	ØE	Kg
E-Style 100 TREND	160	160	95	17	98,2	0,45
E-Style 120 TREND	180	180	101	18	119	0,66
E-Style 150 TREND	200	200	119	22	149	1,04

VERSIONS

- BASE** - On/off through light or remote control switch.
- TIMER** - Integral electronic timer adjustable from 3 to 25 minutes.
- MHT** - Humidity control, adjustable from 40 to 80% of R.H. and Timer adjustable from 3 to 25 mm.



ECO LINE

Wall axial fans
Wall and ceiling installation



ECO GF
FIXED GRILLE



ECO GG
GRAVITY SHUTTER



ECO A
AUTOMATIC



Complies with ErP Directive 2009/125/CE
and EU Regulation 1253/2014

Classification: Residential Ventilation Unit

- To exhaust air directly to the outside or into a short length ducting (max 3 m length).
- Suitable for toilets, bathrooms, WC's, shower-rooms, utility rooms and kitchens.
- Wide range of models all suitable for wall, window and ceiling installation.
- Low energy consumption and high performance for a quick and efficient extraction of stale air.



PERFORMANCE

MODELS	m ³ /h	ls	Pa	W	dB (A)*
ECO 100	90	25	26	11	39
ECO 120	170	47	39	15	42
ECO 150	320	89	69	25	49

* LpA measured at 3 m in open field 230v - 50Hz.

VERSIONS



BASE - On/off through light or remote control switch



TIMER - Integral electronic timer adjustable from 3 to 25 minutes



MHT - Humidity control, adjustable from 40 to 80% of R.H. and Timer adjustable from 3 to 25 mm



2V - 24 hours running at the lowest speed

DIMENSIONS (mm)

MODELS	A	B	C	D	E	Kg.
ECO 100 GF	155	155	92	35	97	0,5
ECO 120 GF	180	180	121	51	119	0,8
ECO 150 GF	209	209	137	52	149	1,2
ECO 100 GG	155	155	92	35	97	0,5
ECO 120 GG	180	180	121	51	119	0,8
ECO 150 GG	209	209	137	52	149	1,2
ECO 100 A	155	155	101	44	97	0,6
ECO 120 A	180	180	121	51	119	0,8
ECO 150 A	209	209	137	52	149	1,2

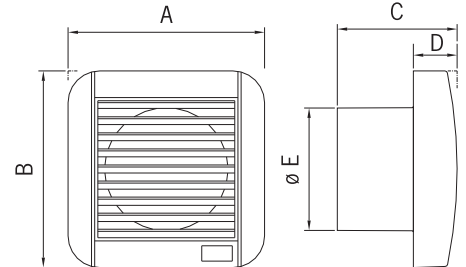

INSTALLATION

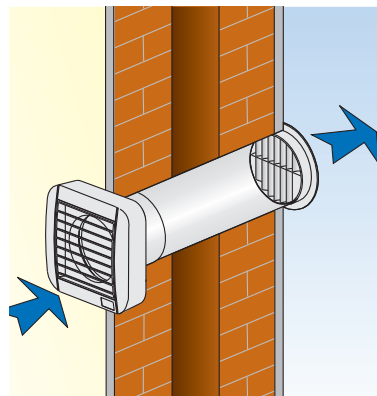

WALL

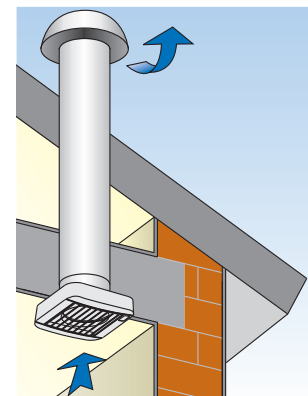

CEILING



ECO LINE

Wall axial fans
Wall and ceiling installation



CURVES

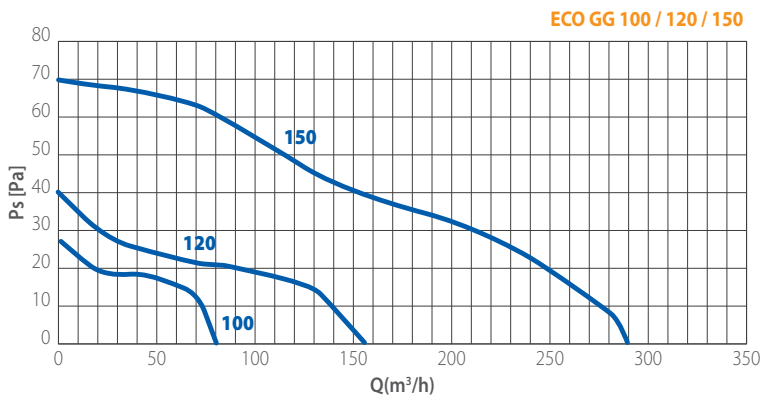
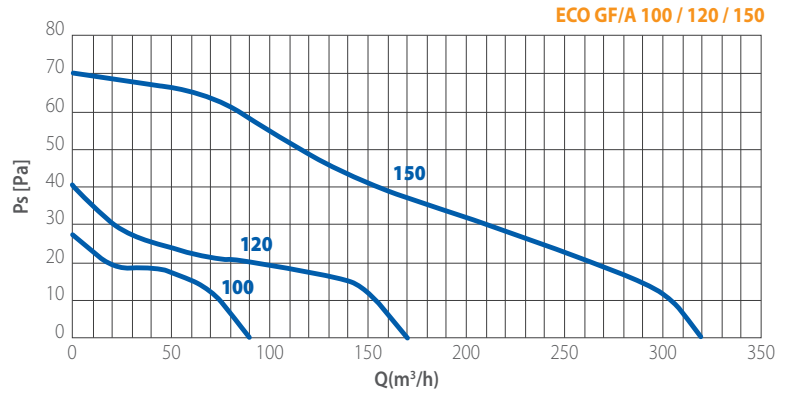

WINDOW KIT



WINDOW KIT GG
(gravity shutter)

Suitable for ECOLINE GF

MODEL
WINDOW KIT GG 100
WINDOW KIT GG 120
WINDOW KIT GG 150



WINDOW KIT GF
(grille fixed)

Suitable for ECOLINE GG and A

MODEL
WINDOW KIT GF 100
WINDOW KIT GF 120
WINDOW KIT GF 150

DIMENSIONS (mm)

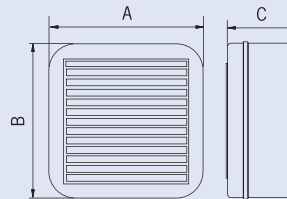

MODEL	A	B	C	Ø glass hole
WINDOW KIT 100	157	157	66	150
WINDOW KIT 120	178	178	82	175
WINDOW KIT 150	208	208	95	175



MINISTYLE

Wall axial fans
Wall installation



Complies with ErP Directive 2009/125/CE
and EU Regulation 1253/2014
Classification: Residential Ventilation Unit

- Ideal for small premises
- Easy to install and extremely compact (front cover 17 mm, height and width 14 mm)
- Made in high quality antistatic technopolymer

INSTALLATION

WALL

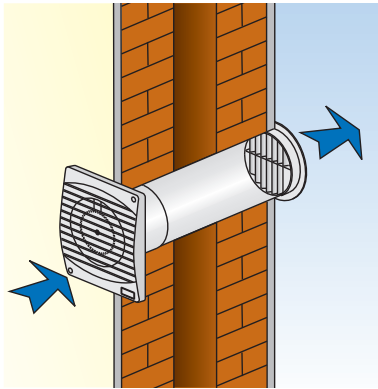

PERFORMANCE

MODEL	m ³ /h	l/s	Pa	W	dB (A)*
MINISTYLE	90	25	26	11	39
MINISTYLE TIMER	90	25	26	11	39

* Lp(A) measured at 3m in open field 230V-50Hz.

CURVES

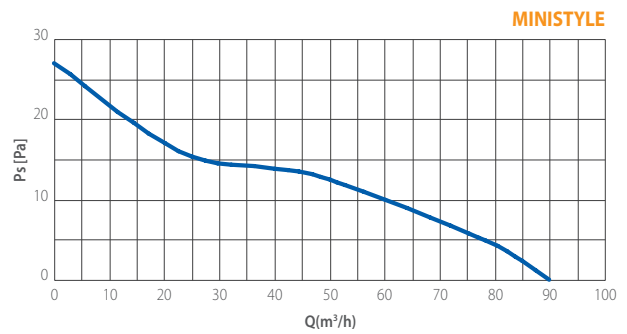

VERSIONS



BASE - On/off through light or remote control switch



PULL CORD - On/off through pull cord switch



TIMER - Integral electronic timer adjustable from 3 to 25 minutes

DIMENSIONS (mm)

MODEL	A	B	C	D	E	Kg.
MINISTYLE	140	140	65	17	98	0,5

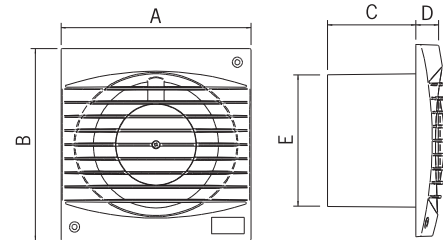



MURO

Wall axial fans
Wall installation



Complies with ErP Directive 2009/125/CE and EU Regulation 1253/2014
Classification: Residential Ventilation Unit

- To exhaust air directly to the outside or into a short length ducting (max 3 m length).
- Suitable for toilets, bathrooms, WC's, shower-rooms, utility rooms and kitchens.
- For wall, panel and ceiling installation.
- Available sizes: Ø100, Ø120, Ø150.
- Manufactured in shock-proof high quality technopolymer.
- Maintenance free, self lubricating sleeve bearing motor for long life and noiseless running.
- Induction motor with overheating protection 230V – 50 Hz.
- Easy maintenance and cleaning.
- MURO 100 A with electric opening of the grille.



PERFORMANCE

MODELS	m ³ /h	Pa	W	dB(A)	PROTECTION
MURO 100	95	29	11	39	IPX4
MURO 120	180	43	15	42	IPX4
MURO 150	320	70	25	49	IPX4
MURO 100 A	110	35	11	39	IPX4

* Lp(A) measured at 3m in open field 230V-50Hz.

CURVES

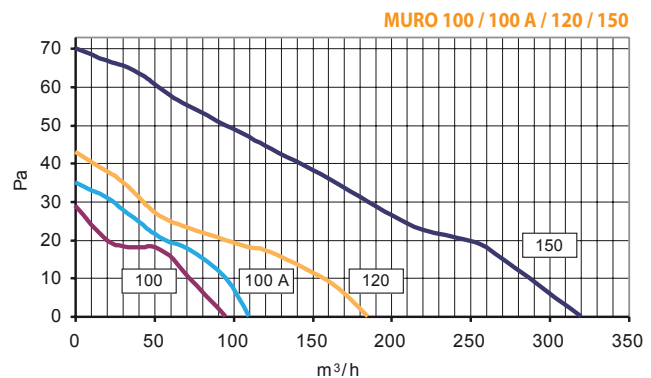

VERSIONS



BASE - On/off through light or remote control switch.



TIMER - Integral electronic timer adjustable from 3 to 25 minutes

INSTALLATION

WALL

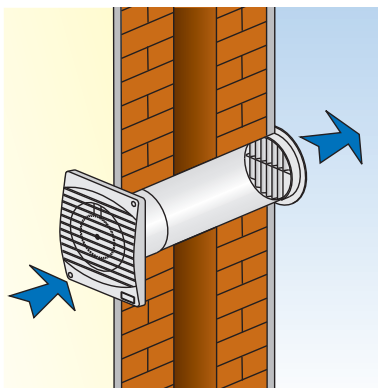

DIMENSIONS (mm)

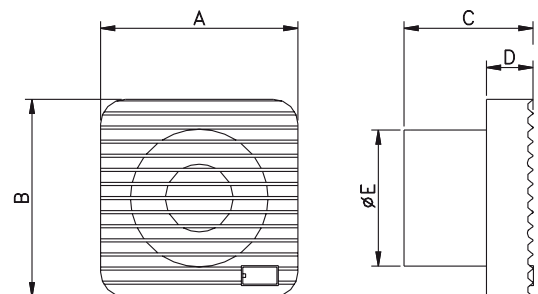

MODEL	A	B	C	D	E	Kg
MURO 100	140	140	92	33	97	0,7
MURO 100 A	155	155	91	37	97	0,8
MURO 120	160	160	103	33	119	0,8
MURO 150	180	180	128	33	148	1,2



TUBO

Axial in-line duct fans
Wall and ceiling installation



Complies with ErP Directive 2009/125/CE
and EU Regulation 327/2011
Classification: FAN

- Suitable for intake / extract ventilation
- Ideal for conveying air between two separate rooms
- Invisible and efficient: no fan into the room
- Metal or Technopolymer versions
- Long Life sleeve bearing motor
- TUBO LAM: Class I protection

PERFORMANCE

MODELS	m ³ /h	l/s	Pa	W	dB (A)*
TUBO 100	90	25	25	11	38
TUBO 120	180	50	35	15	44
TUBO 150	320	89	69	40	51

* Lp(A) measured at 3m in open field 230V-50Hz.

CURVES

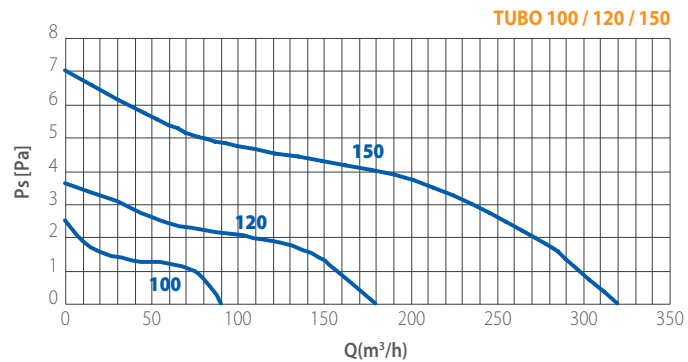

INSTALLATION

WALL

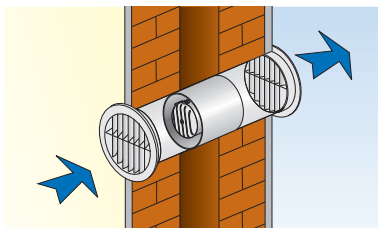

CEILING

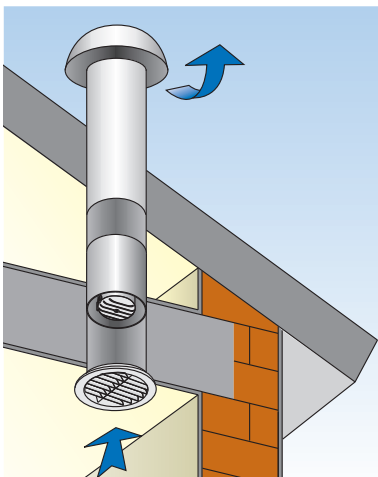

VERSIONS



BASE - On/off through light or remote control switch.

TIMER - Integral electronic timer adjustable from 3 to 25 minutes (available on TUBO TP only).

DIMENSIONS (mm)

MODELS	A	ØB	Kg.
TUBO 100	92	97	0,4
TUBO 120	97	119	0,6
TUBO 150	125	151	0,8

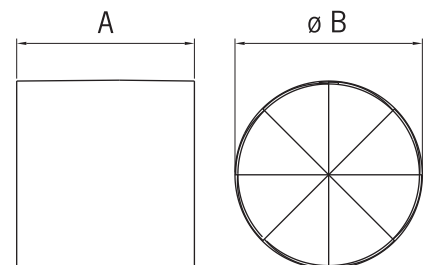



BUILT-IN

Built-in wall axial fans
Wall installation



Complies with ErP Directive 2009/125/CE
and EU Regulation 327/2011
Classification: FAN

- Extract/Intake models available in 2 sizes: 9" and 12" (with same wall hole sizes)
- Built-in 9 available in Low capacity version
- Stylish profile and unobtrusive installation
- High efficiency (up to 1630 m³/h)
- Silent shutter operation via thermal actuator
- Made in shockproof high quality technopolymer
- Sleeve bearing motor



PERFORMANCE

MODELS	m ³ /h	l/s	Pa	W	dB (A)**	Kg
BUILT-IN 9	* 740 / 480	205 / 133	46 / 35	46	48	11,5
BUILT-IN 12	* 1630 / 850	453 / 236	75 / 48	106	58	12,5
BUILT-IN 9LC	* 600 / 374	167 / 104	42 / 35	29	48	11,5

* Extract / Intake

** Lp(A) measured at 3m in open field 230V-50Hz.

DIMENSIONS (mm)

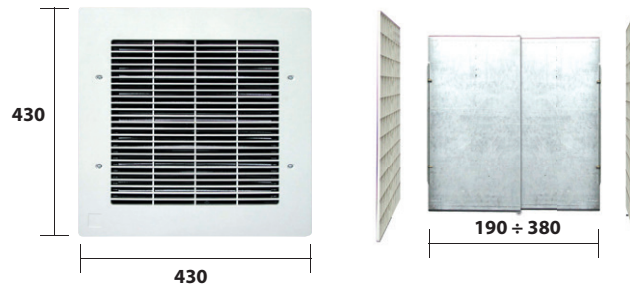

INSTALLATION

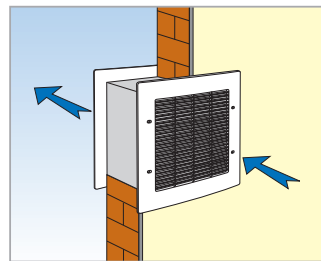

Hole dimensions
(same hole size for 9" and 12")

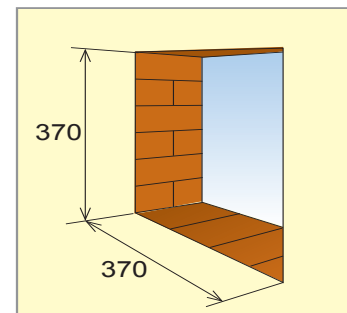



JOLLY PLUS

Wall axial fans
Wall installation



PERFORMANCE

MODELS	m ³ /h	l/s	Pa	W	dB(A)
JOLLY PLUS 100	90	25	18	11	39
JOLLY PLUS 120	175	49	35	15	43
JOLLY PLUS 150	320	89	71	40	51

* Lp(A) measured at 3m in open field 230V-50Hz.

- Wall axial fans suitable for direct exhaust (max duct length 1,5 m).
- Complete range ø 100, 120, 150 mm.
- Compact sizes.
- Manufactured in shock-proof high quality technopolymer.
- Maintenance free, self-lubricating sleeve bearing motor for long life.
- Induction motor with overheating protection 230V - 50/60 Hz.
- Easy installation, maintenance and cleaning.
- Available with back draught shutters upon request.

CURVES

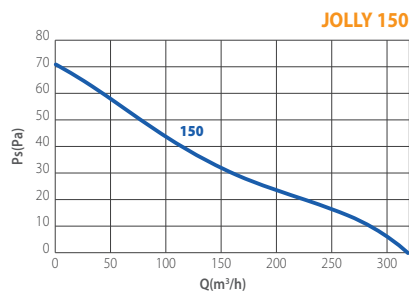
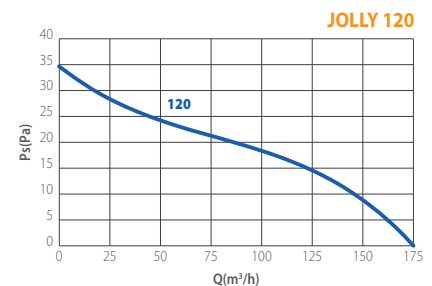
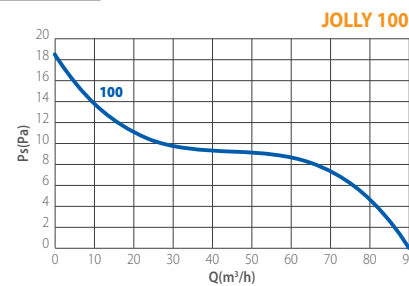

VERSIONS



BASE - On/Off via light/remote control switch



PULL CORD - On/Off via pull cord switch



TIMER - Integral electronic timer adjustable from 3 to 25 minutes

INSTALLATION

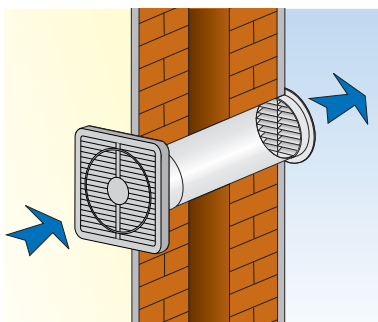

DIMENSIONS (mm)

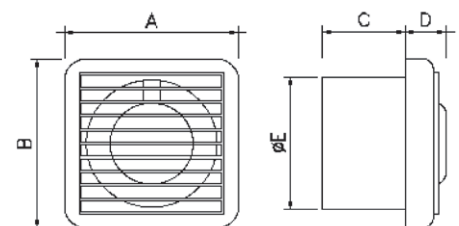

MODEL	A	B	C	D	E	kg
JOLLY 100	125	125	63	29	97	0,7
JOLLY 120	150	150	73	29	118	0,8
JOLLY 150	185	185	93	29	151	1,0



Complies with ErP Directive 2009/125/CE and EU Regulation 1253/2014
Classification: Residential Ventilation Unit

- Special version of ECO LINE with automatic shutters and provided with assembled kit for window installation.
- To exhaust air directly to the outside or into a short length ducting (max 3 m length).
- Suitable for toilets, bathrooms, WC's, shower-rooms, utility rooms and kitchens.



PERFORMANCE

MODELS	PROTECTION	m ³ /h	l/s	W	Pa	dB(A)*
ECOWIND 100 A	IPX4	90	25	13	20	42
ECOWIND 120 A	IPX4	130	36	15	31	44
ECOWIND 150 A	IPX4	260	72	25	60	51

**Lp(A) measured at 3m in open field 230V-50Hz.

CURVES

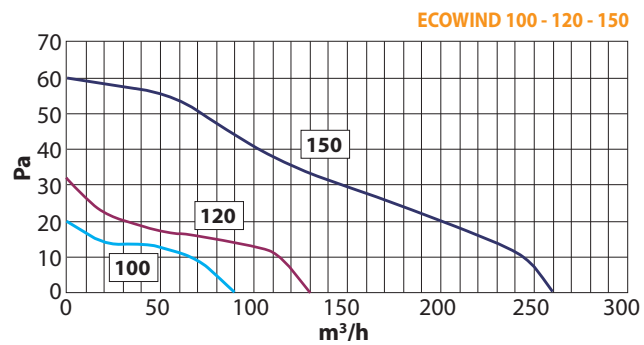

DIMENSIONS (mm)

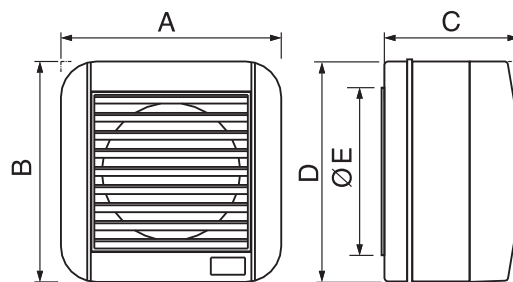

MODELS	A	B	C	D	ØE	Kg
ECOWIND 100 A	155	155	110	157	150	0,8
ECOWIND 120 A	180	180	132	178	175	1,0
ECOWIND 150 A	209	209	147	208	175	1,4

INSTALLATION

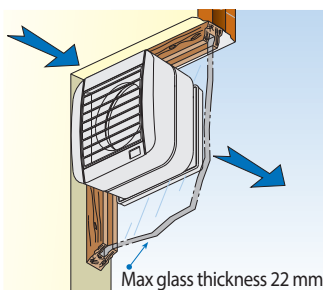

WINDOW
(with window kit)



Complies with ErP Directive 2009/125/CE and EU Regulation 327/2011
Classification: FAN



PERFORMANCE

MODELS	m ³ /h	l/s	Pa	W	dB (A)**	MARKED
VITRO 6/150 LC-M	200	56	36	24	40	Ⓜ
VITRO 6/150 LC-A	200	61	36	28	40	Ⓜ
VITRO 6/150 P-M	300	83	74	40	48	Ⓜ
VITRO 6/150 P-A	300	83	74	40	48	Ⓜ
VITRO 9/230 LC-M	600	167	42	29	50	-
VITRO 9/230 LC-AR	*600 / 374	167 / 104	42 / 35	29	50	-
VITRO 9/230 P-M	700	194	52	43	50	Ⓜ
VITRO 9/230 P-AR	*700 / 400	194 / 111	55	46	50	Ⓜ
VITRO 12/300 AR	*1,400 / 800	389 / 222	83	84	59	Ⓜ

* Extract / Intake

** Lp(A) measured at 3m in open field 230V-50Hz.

- High extract performance for polluted premises, ideal for commercial environments.
- Suitable for wall, double window and double glazed window installation (accessories upon request).
- 9" and 12" (automatic versions) are suitable for reverse running.
- IPX4 on external part only.

VERSIONS



MANUAL - Pull cord switch



AUTOMATIC - Automatic electrical opening of the shutter. On/Off via light/remote switch



AUTOMATIC REVERSIBLE - Automatic electrical opening of the shutter. On/Off via light/remote switch. + Reversible air flow through reversible speed controller RVS/R



POTENTIATED - Potentiated motor for higher airflow performance



LOW CAPACITY - (LCM - Low capacity Manual / LC-AR Low capacity Automatic Reversible)

CURVES

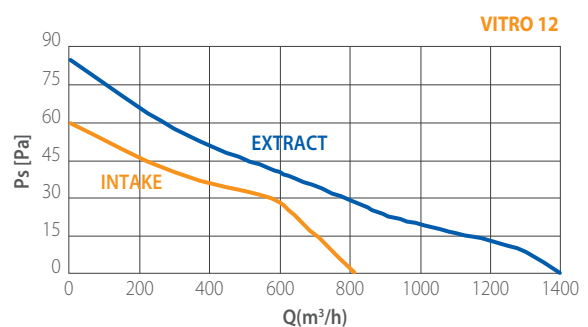
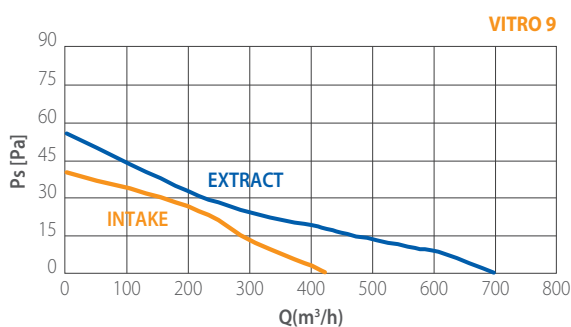
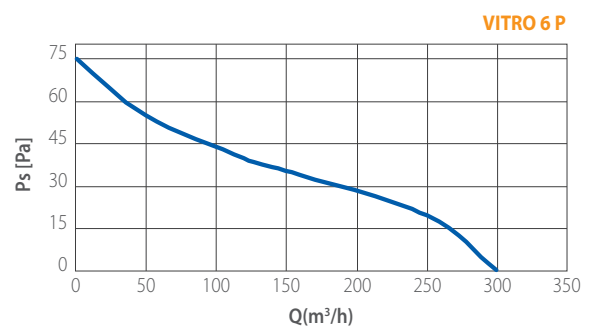
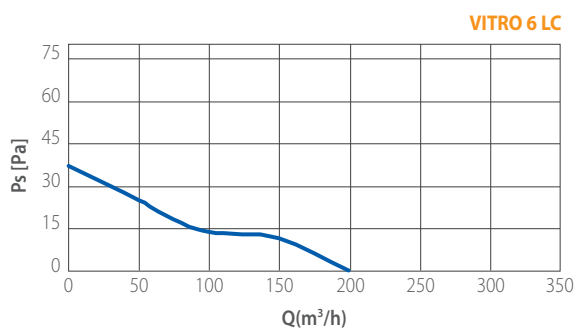



DIMENSIONS (mm)

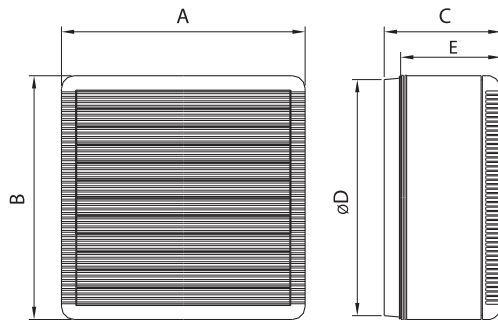

MODELS	A	B	C	ØD	E	Kg.
VITRO 6/150	195	195	126	184+188	102	1,7
VITRO 9/230	287	287	138	254+258	122	3,5
VITRO 12/300	364	364	162	324+329	137	5

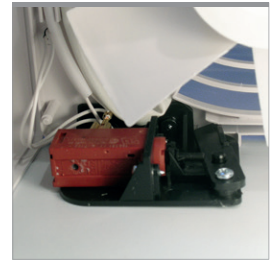

Thermoactuator for the electrical opening of the grille.



Pull cord switch version.

INSTALLATION

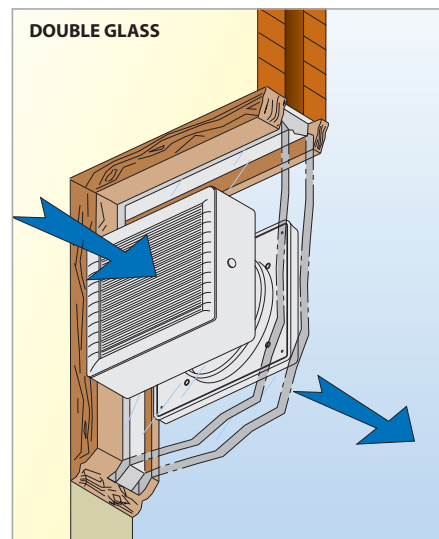
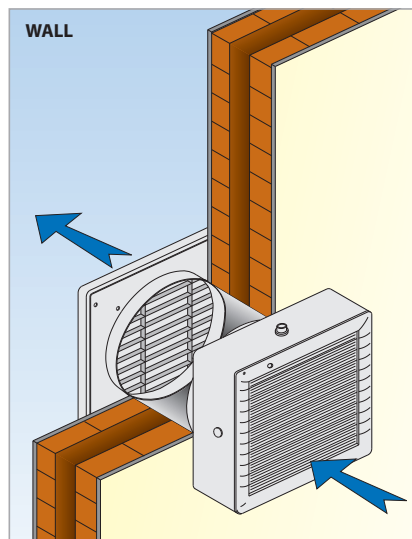
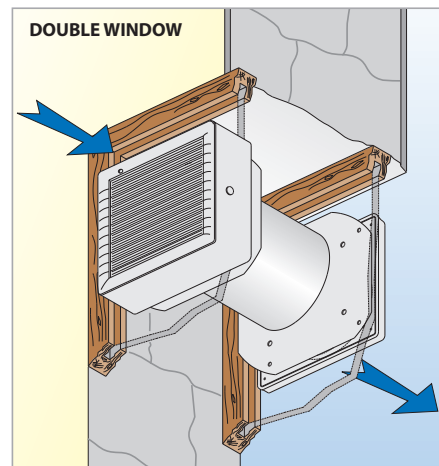
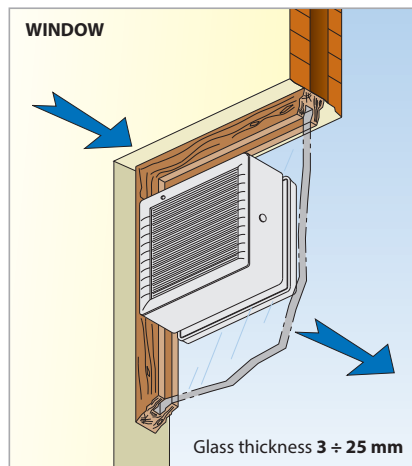



MINIVITRO

Window axial fans
Window installation



Complies with ErP Directive 2009/125/CE
and EU Regulation 327/2011

Classification: FAN

- Special version of VITRO suitable for wall or window installation, to exhaust air directly to the outside or into a short length ducting.
- Compact dimensions.
- Model A with automatic shutter and external fixed grille.



PERFORMANCE

MODELS	Protection	m ³ /h	l/s	dB(A)*	Pa	W
MINIVITRO 4/100 A MFE	IPX4	90	25	39	19	11
MINIVITRO 4/100 MGE	IPX2-IPX4	90	25	40	33	11
MINIVITRO 5/120 MGE	IPX2-IPX4	160	44	43	51	15
MINIVITRO 6/150 MGE	IPX2	200	56	43	51	25

* Lp(A) measured at 3 m in open field 230V/50Hz

A = automatic - MGE = with external gravity shutter - MFE = with external fixed grille.

DIMENSIONS (mm)

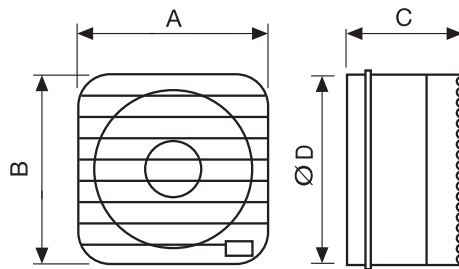

MODEL	A	B	C	ØD
MINIVITRO 4/100 A MFE	155	155	99	152
MINIVITRO 4/100 MGE	155	155	99	152
MINIVITRO 5/120 MGE	160	160	109	152
MINIVITRO 6/150 MGE	180	180	112	176



Complies with ErP Directive 2009/125/CE and EU Regulation 1253/2014
Classification: Residential Ventilation Unit

- Centrifugal duct fan Ø100 mm with central outlet.
- Innovative design with flat front cover and lateral intake.
- Available with EC motor for a perfect combination of style and performance.
- Provided with sliding filter in PP removable and washable in dishwasher and with back-draught shutters.



PERFORMANCE

MODEL	DUCT Ø	m³/h	l/s	Pa	W	dB(A)*
Base - Pull cord - Timer - MHY smart - SELV						
ELIX 100	100	97	27	151	29	42
CMT Comfortimer - 2 V						
ELIX 100	100	97 / 54	27 / 15	151 / 116	29 / 14	42 / 23

* Lp(A) measured at 3m in open field 230V-50Hz.

VERSIONS

- BASE** - On/off through light or remote control switch
- PULL CORD** - On/off through pull cord switch
- TIMER** - Integral electronic timer adjustable from 3 to 25 minutes
- CMT - COMFORTIMER** - Overrun timer at low speed
- MHY** - Smart Humidity control automatic progressive increase/decrease of fan speed according to the percentage of Relative Humidity
- 2 V** - 24 hours running at the lowest speed
- 2 V MHT** - 2 speed MHT with humidity control
- EC VERSIONS** - See pag. 72

INSTALLATION

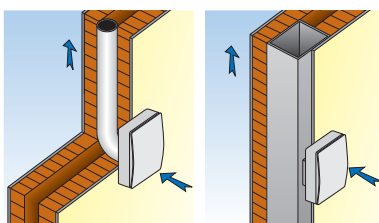

MULTIPLE DUCT

SINGLE DUCT

CURVES

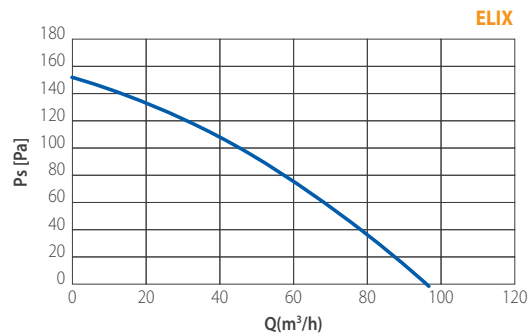

DIMENSIONS (mm)

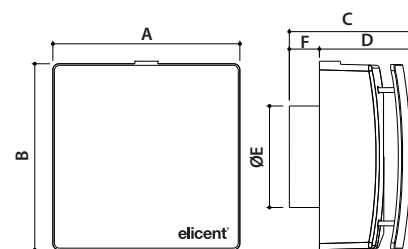

MODEL	A	B	C	D	ØE	F	Kg
ELIX 100	180	180	116	87	99	29	2,6

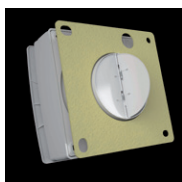

Antivibration gasket



Central outlet

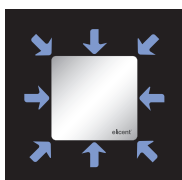

Lateral intake on the whole perimeter



Sliding filter



Complies with ErP Directive 2009/125/CE and EU Regulation 1253/2014
Classification: Residential Ventilation Unit

- Powerful centrifugal duct fan Ø100 mm with decentralised outlet.
- Innovative design with flat front cover and lateral intake. Suitable for surface or built-in installation (wall/ceiling mounted).
- Casing for built-in installation on request
- Provided with removable filter in PP washable in dishwasher and with back-draught shutters.



PERFORMANCE

MODEL	DUCT Ø	m³/h	l/s	Pa	W	dB (A)*
Standard - Pull Cord - Timer - MHY						
ELPREX 100	100	221	61	208	29	41
CMT Comfortimer - 2V - MHT 2V						
ELPREX 100	100	221	61	208	29	41

* Lp(A) measured at 3m in open field 230V-50Hz.

CURVES

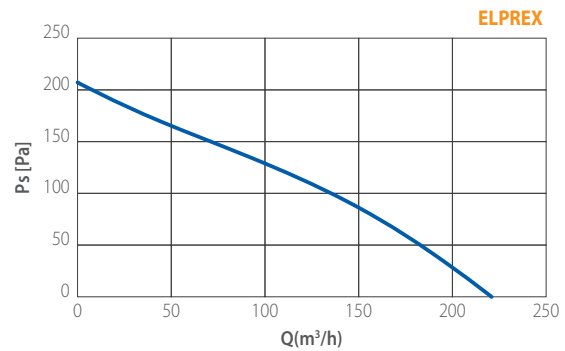

VERSIONS

- BASE** - On/off through light or remote control switch
- PULL CORD** - On/off through pull cord switch
- TIMER** - Integral electronic timer adjustable from 3 to 25 minutes
- CMT - COMFORTIMER** - Overrun timer at low speed
- MHT** - Humidity control, adjustable from 40 to 80% of R.H. and Timer adjustable from 3 to 25 mm
- 2V** - 24 hours running at the lowest speed



Decentral outlet



Built-in kit

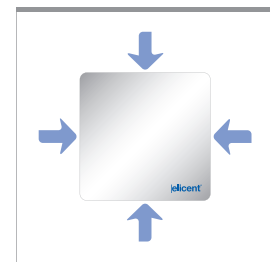

Lateral intake



DIMENSIONS (mm)

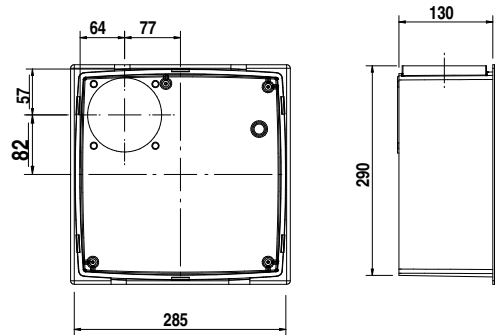
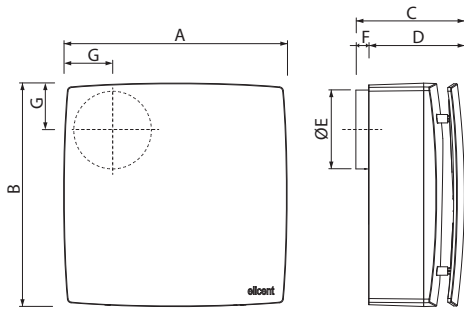

TYPE	A	B	C	D	ØE	F	G	Kg
ELPREX	280	280	135	120	99	16	58	2,8

Casing for built-in installation
(to be ordered separately)

INSTALLATION

SURFACE

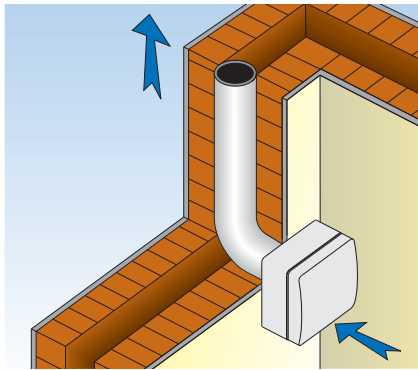

SINGLE DUCT

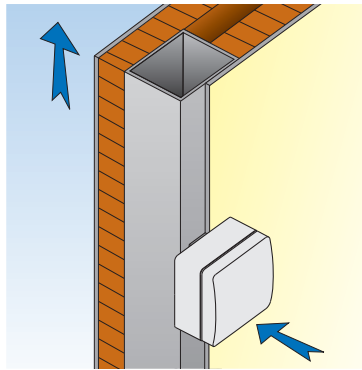

MULTIPLE DUCT

BUILT-IN

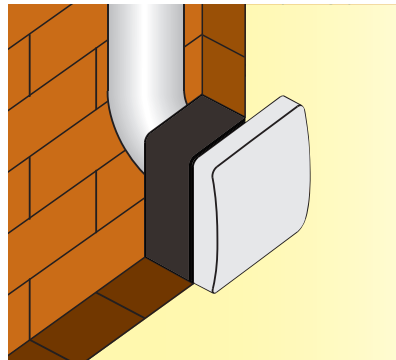
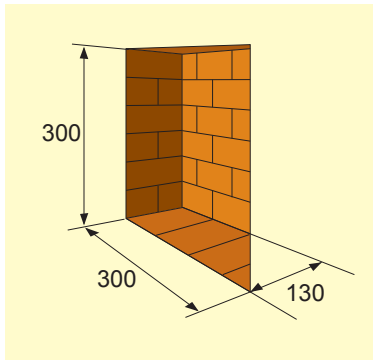

REAR OUTLET

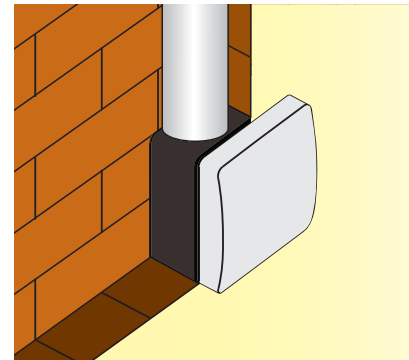

VERTICAL OUTLET



Complies with ErP Directive 2009/125/CE and EU Regulation 1253/2014
Classification: Residential Ventilation Unit

- Centrifugal duct fans with central outlet
- 2 models: 100 and 250, Ø100 and 120 mm



PERFORMANCE

MODELS	DUCT Ø	m³/h	l/s	Pa	W	dB (A)*
Standard - Timer - MHT - Pull Cord						
FLUX 100	100	90	25	124	30	44
2V - MHT 2V						
FLUX 100 2V	100	90 / 38	25/10	124 / 78	30 / 12	44/37
Selv - Selv Timer						
FLUX 100 SELV	100	90	25	124	26	44
Standard - Timer - MHT						
FLUX 250 / Ø 100	100	201	56	195	29	52
FLUX 250 / Ø 120	120	232	64	195	29	52

* Lp(A) measured at 3m in open field 230V-50Hz.

VERSIONS



BASE - On/off through light or remote control switch



PULL CORD - On/off through pull cord switch



TIMER - Integral electronic timer adjustable from 3 to 25 minutes



MHT - Humidity control, adjustable from 40 to 80% of R.H. and Timer adjustable from 3 to 25 min



2V - 24 hours running at the lowest speed



2V MHT - 2 speed MHT with humidity control



SELV SELV 12 V a.c.



Antivibration gasket



Backdraught shutter



Central outlet

CURVES

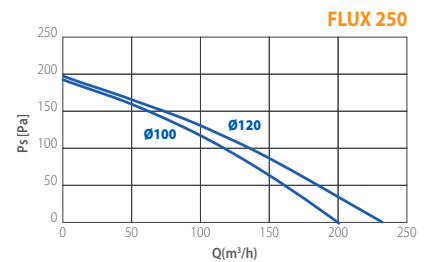
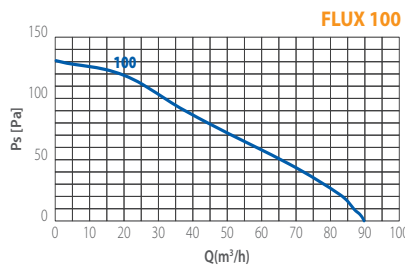

INSTALLATION

SINGLE DUCT

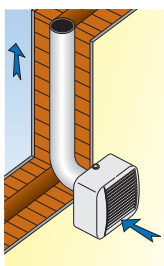

MULTIPLE DUCT

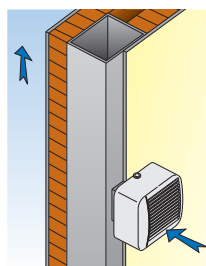

DIMENSIONS (mm)

MODELS	A	B	C	D	ØE	F	Kg.
FLUX 100	160	160	119	89	97	30	0,8
FLUX 250/100	210	210	156	131	97	25	1,8
FLUX 250/120	210	210	156	131	119	25	1,8

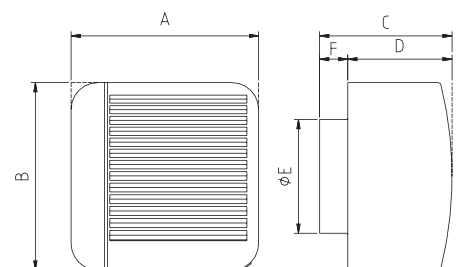



RADIA

Centrifugal duct fans
Duct installation



Complies with ErP Directive 2009/125/CE
and EU Regulation 1253/2014
Classification: Residential Ventilation Unit

- Classical centrifugal fans designed to overcome the pressure and resistance caused by long lengths of ducting.
- Provided with back draught shutter and removable filter.



PERFORMANCE

MODELS	DUCT Ø	m³/h	l/s	Pa	W	dB (A)*
RADIA 80	80/100	80	22	108	23	39
RADIA 130	100	130	36	177	29	44
RADIA 220	100	214	59	277	29	50

* Lp(A) measured at 3m in open field 230V-50Hz.

CURVES

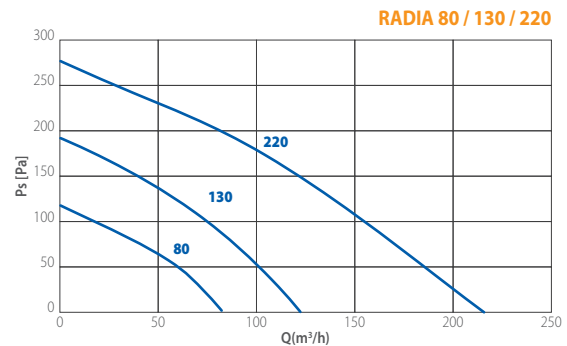

VERSIONS



BASE - On/off through light or remote control switch



PULL CORD - On/off through pull cord switch



TIMER - Integral electronic timer adjustable from 3 to 25 minutes



MHT (Radia 80 - 130 only) - Humidity control, adjustable from 40 to 80% of R.H. and Timer adjustable from 3 to 25 min.



2 V (Radia 80 - 130 only) - 24 hours running at the lowest speed



MHT - 2V (Radia 80 - 130 only) - Humidity control, adjustable from 40 to 80% of R.H.



Decentral outlet



Backdraught shutter

INSTALLATION

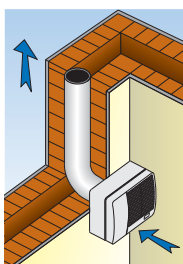

SINGLE DUCT

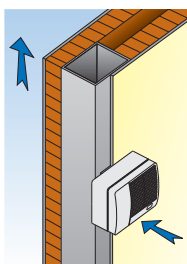

MULTIPLE DUCT

DIMENSIONS (mm)

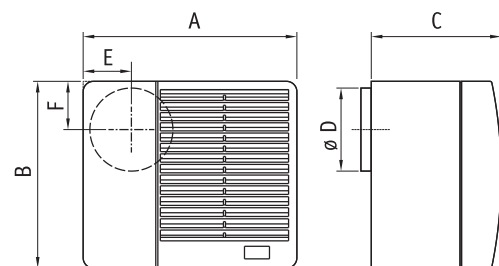

MODELS	A	B	C	Ø D	E	F	Kg.
* RADIA 80	206	180	135	80	48	47	1,2
RADIA 130	237	211	146	98	57	56	1,8
RADIA 220	304	256	171	98	56	61	3

* Supplied with adaptor for ducts Ø100 mm



TIRAFUMO

Roof radial extract fans for fireplaces
Outdoor installation



The series is not affected by the ErP Directive 2009/125/CE and further Regulations.

- Ideal for improving the draught of residential fireplaces
- Suitable for chimneys with a section of max 150 x 150 mm (equivalent \varnothing 170 mm) and air temperature of max. 200°C in continuous running
- Easy installation (just Plug & Play)
- Made in steel or copper with highly resistant epoxy finish



PERFORMANCE

MODEL	m ³ /h	l/s	Pa	W	A	dB (A) *
TIRAFUMO	850	236	190	97	0,52	52,5

* Lp(A) measured at 3m in open field 230V-50Hz.

VERSIONS

TIRAFUMO / N - Steel

TIRAFUMO / NC - Copper

DIMENSIONS (mm)

MODEL	A	B	C	\varnothing D	d	Kg.
TIRAFUMO	400	420	540	178	360	22

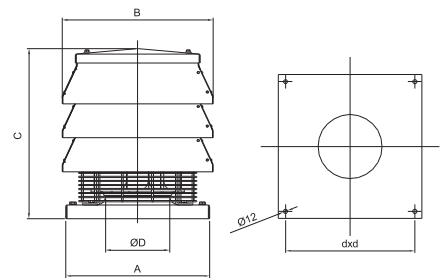

INSTALLATION

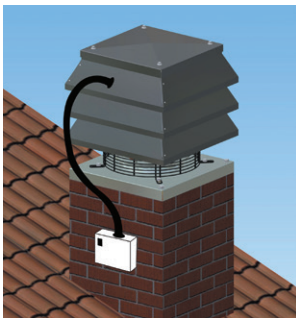

CURVES

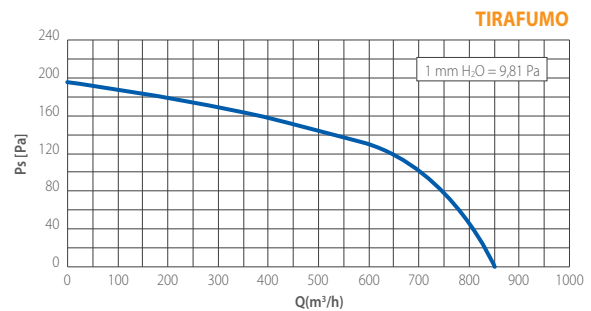

SUPPLIED



Counterbase to wall up



Plug-in junction box



Eyebolts



Electronic speed controller **R15**



- Rotating chimney cowl - circular base - designed to eradicate downdraught, whilst the rotating action assists ventilation.
- Circular base on double ball bearings
- Made of stainless steel antimagnetic AISI 304 (Din 1.4301) with external glossy finish (BA) and thickness equal to 4/10 mm (80-250 mm), 5/10 mm (300-500mm), 6/10 mm (400-600 mm)
- It does not use electricity but exploits the action of the wind and guarantees the ventilation and air exchange in rooms technicians such as electrical cabins, gas cabins, septic tanks, and confined environments generally. It also allows for evacuation of fumes and vapors, increasing the draft of the chimney
- The connection joint is of type male / female with connection mechanics between the elements ensured from the fixing brackets
- Single wall system consisting of modular elements with circular section, CE marked in compliance with the EN standard 1856-1.
- The product is suitable for air, vapors, fumes, with maximum temperature up to 600 °C (T600), for operation in depression (N1), even in the presence of condensation (wet operation)
- Longitudinal welding is made with Laser and Tigrando processes in protected atmosphere
- It is possible to combine the installation with an installation kit made of the following elements:

- a linear element of height equal to 25 mm, made of stainless steel 316, to be fixed to the structure of the building
- a fixing bracket in stainless steel 304
- a protection cover realized 304 stainless steel

PERFORMANCE

MODEL	WIND SPEED	MAX AIRFLOW AT 15°C and 1.013 mbar
	m/s	m³/h
Wind direction according to horizon: 0°		
ELIAIR 80/100/120/130	2,5	51,7
	5	127
	10	290
	15	448,4
ELIAIR 140/150/160	2,5	51,9
	5	127,1
	10	290,1
	15	448,6
ELIAIR 180/200	2,5	96,5
	5	223,4
	10	449
	15	684,7
ELIAIR 230	2,5	133,4
	5	311,3
	10	670,2
	15	1.028
ELIAIR 250	2,5	175,9
	5	399,2
	10	1.143,2
	15	1.781
ELIAIR 300/350	2,5	218,4
	5	485,2
	10	1.745,2
	15	2534
ELIAIR 400	15	3.391
	10	2.215
	5	1.021
	2,5	452
ELIAIR 450	15	4.291
	10	2.804
	5	1.292
	2,5	572
ELIAIR 500	15	5.298
	10	3.461
	5	1.596
	2,5	706
ELIAIR 550	15	6.411
	10	4.188
	5	1.931
	2,5	854
ELIAIR 600	15	7.630
	10	4.985
	5	2.298
	2,5	1.017

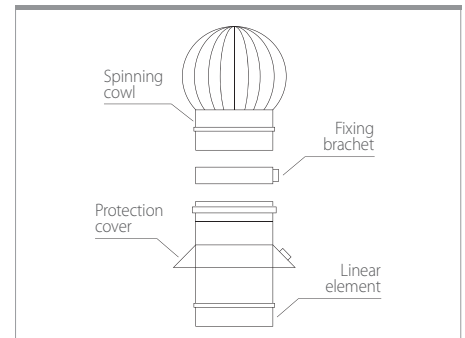

INSTALLATION

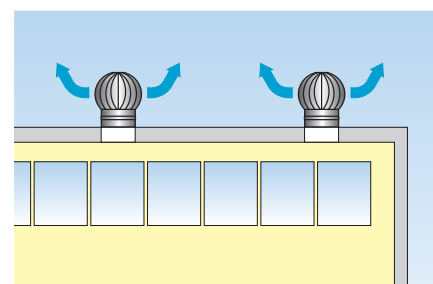
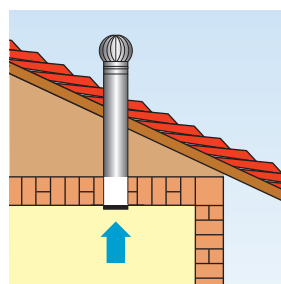



DIMENSIONS (mm)

Type	Di	Ds	Hu	l	Weight
	mm	mm	mm	mm	kg
ELIAIR 80	80	200	220	55	1,1
ELIAIR 100	100	200	220	55	1,15
ELIAIR 120	120	200	220	55	1,2
ELIAIR 130	130	200	220	55	1,25
ELIAIR 140	140	220	220	55	1,3
ELIAIR 150	150	220	220	55	1,4
ELIAIR 160	160	220	220	55	1,45
ELIAIR 180	180	300	290	55	1,7
ELIAIR 200	200	300	290	55	2,1
ELIAIR 230	230	360	340	55	2,8
ELIAIR 250	250	360	340	55	3,1
ELIAIR 300	300	390	320	55	3,3
ELIAIR 350	350	440	320	55	3,8
ELIAIR 400	400	500	530	55	7
ELIAIR 450	450	550	510	55	7,25
ELIAIR 500	500	600	500	55	7,5
ELIAIR 550	550	650	480	55	7,75
ELIAIR 600	600	700	450	55	8

Spinning cowl

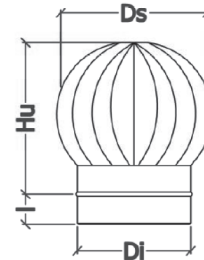

TYPE	Di	Hu	l	Weight
	mm	mm	mm	kg
ELIAIR 80	80	190	55	0,2
ELIAIR 100	100	190	55	0,25
ELIAIR 120	120	190	55	0,3
ELIAIR 130	130	190	55	0,31
ELIAIR 140	140	190	55	0,35
ELIAIR 150	150	190	55	0,37
ELIAIR 160	160	190	55	0,4
ELIAIR 180	180	190	55	0,45
ELIAIR 200	200	190	55	0,5
ELIAIR 230	230	190	55	0,58
ELIAIR 250	250	190	55	0,63
ELIAIR 300	300	190	55	0,94
ELIAIR 350	350	190	55	1,1
ELIAIR 400	400	190	55	1,51
ELIAIR 450	450	190	55	1,69
ELIAIR 500	500	190	55	1,88
ELIAIR 550	550	190	55	2,07
ELIAIR 600	600	190	55	2,26

Linear element Hu. 190

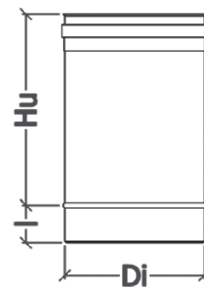

TYPE	Di	H	Weight
	mm	mm	kg
ELIAIR 80	80	18	0,04
ELIAIR 100	100	18	0,05
ELIAIR 120	120	50	0,06
ELIAIR 130	130	50	0,07
ELIAIR 140	140	50	0,08
ELIAIR 150	150	50	0,09
ELIAIR 160	160	50	0,1
ELIAIR 180	180	50	0,12
ELIAIR 200	200	50	0,14
ELIAIR 230	230	50	0,17
ELIAIR 250	250	50	0,19
ELIAIR 300	300	50	0,23
ELIAIR 350	350	50	0,25
ELIAIR 400	400	50	0,28
ELIAIR 450	450	50	0,31
ELIAIR 500	500	50	0,33
ELIAIR 550	550	50	0,36
ELIAIR 600	600	50	0,39

Fixing bracket



TYPE	Di	Da	H	Weight
	mm	mm	mm	kg
ELIAIR 80	80	206	45	0,17
ELIAIR 100	100	226	45	0,18
ELIAIR 120	120	246	45	0,21
ELIAIR 130	130	256	45	0,22
ELIAIR 140	140	266	45	0,23
ELIAIR 150	150	276	45	0,24
ELIAIR 160	160	286	45	0,25
ELIAIR 180	180	306	45	0,28
ELIAIR 200	200	326	45	0,3
ELIAIR 230	230	356	45	0,32
ELIAIR 250	250	376	45	0,35
ELIAIR 300	300	426	45	0,38
ELIAIR 350	350	476	45	0,4
ELIAIR 400	400	526	45	0,43
ELIAIR 450	450	576	45	0,5
ELIAIR 500	500	626	45	0,55
ELIAIR 550	550	676	45	0,6
ELIAIR 600	600	726	45	0,68

Weatherproof protection cover





AXR

Centrifugal in-line fans for RADON mitigation



Complies with ErP Directive 2009/125/CE and EU Regulation 327/2011
Classification: FAN



FEATURES

- In-line centrifugal fans for residential or commercial application where the presence of the Radon gas is ascertained or presumed.
- Suitable for clean air with max. temperature of 50°C
- Housing in self-extinguishing V2 technopolymer
- Tight sealing
- Self-cleaning backward curved blades
- Supplied with connection cable long 1,2 m
- Statically and dynamically balanced according to ISO 1940
- Single-phase ball bearing motor (230V-50Hz) provided with thermal cut-out, suitable for continuous running
- Class II insulation (no earth connection needed)
- Complies with CEI EN 60335-2-80, EMC 2014/30/EU and LVD 2014/35/EU

INSTALLATION

Radon is a colorless, chemically inert and radioactive odorless gas present in some soils from which it is produced and dispersed in the environment, accumulating in closed rooms where it becomes dangerous. Once accumulated, the Radon can be breathed in and continue the radioactive series within the body, with great damage to health, increasing the risk of developing pulmonary neoplasms. Epidemiological studies published by the World Health Organization (WHO) and the International Agency for Research on Cancer (IARC) have now scientifically established the carcinogenicity of this gas.

The presence of indoor radon is for the most part due to a pressure difference between the external and internal environment; in fact, a cause of the temperature difference, the air pressure inside is smaller, so a gas suction is generated from the outside towards the inside. For good reason, the Radon emitted from the ground is sucked up, it goes up the lower floors and spreads in the rooms of daily use.

In the event that the presence of Radon gas inside a house has been ascertained or is simply presumed, the **most effective intervention** to mitigate its dangerousness and consequently reduce the risks for human health consists in the **creation of a sump** in the basement of the adjacent rooms in order to favor the entry of the Radon gas (which is heavier than air), to then **capture it and convey it through AXR fan at a safe distance from the house**. In this objective it is always good practice to contact qualified installers for a correct sizing.

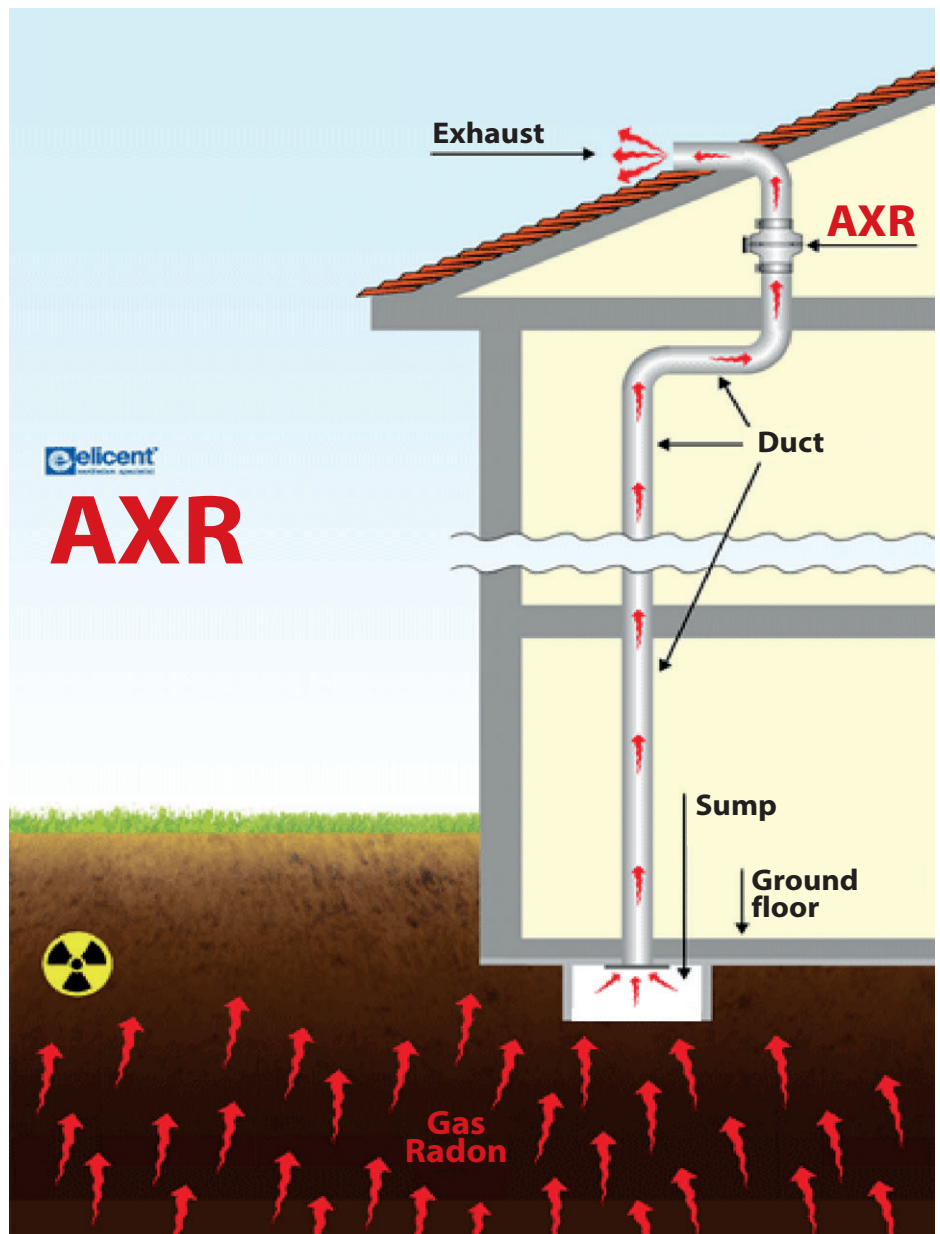



PERFORMANCE

MODEL	DUCT	AIRFLOW	l/s	PRESSURE MAX	A	W	SOUND PRESSURE (at 3 m)	PROTECTION
	Ø mm	m³/h		Pa			dB (A)*	
AXR 100	100	211	59	263	0,13	27	32	IPX5
AXR 125	125	265	74	251	0,13	27	33	IPX5
AXR 150	150	430	117	325	0,29	65	39	IPX5
AXR 160	160	450	123	325	0,29	65	40	IPX5

* Sound pressure at 3 m with fan ducted.

DIMENSIONS (mm)

MODEL	A	B	ØC	ØD	Kg.
AXR 100	238	25	98	212	1,5
AXR 125	238	25	123	212	1,5
AXR 150	232	28	147	253	2
AXR 160	232	28	157	253	2

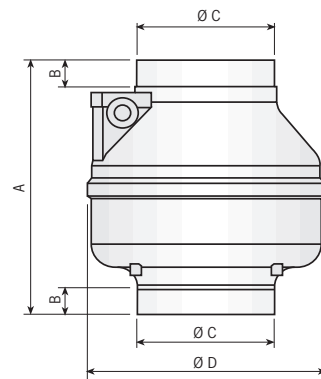

CURVES

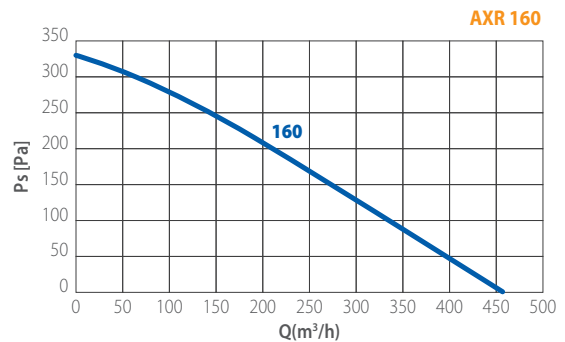
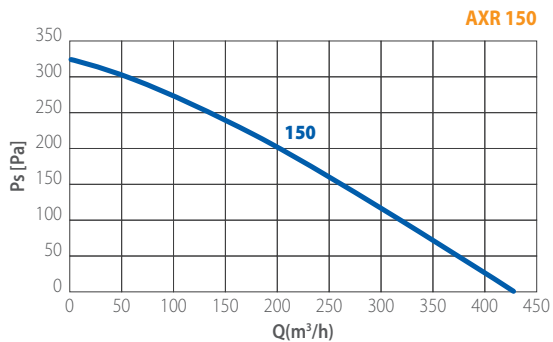
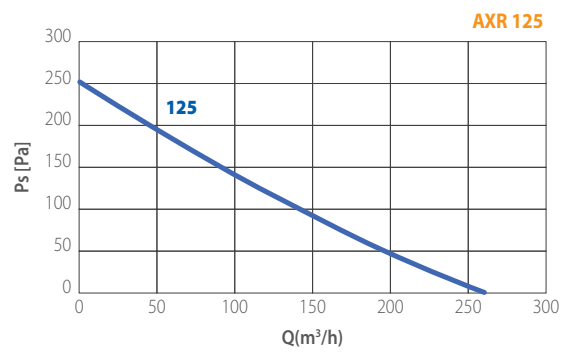
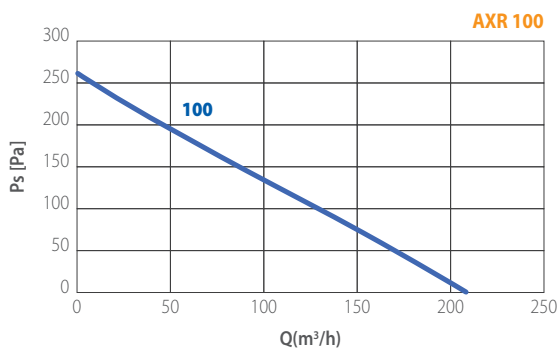

RESIDENTIAL AND COMMERCIAL EXTRACT VENTILATION

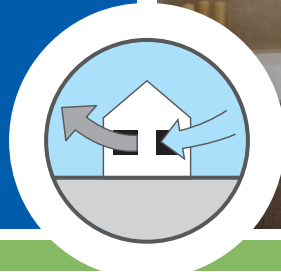

EC brushless Fans



FACTS AND FIGURES

Many studies have documented that electric motors used in the building field are responsible for over a third of all electricity consumed and that about 65% of this energy is used to power centrifugal pumps and fans.

These figures outline that the electric motors absorb one of the most important consumption share of HVAC systems. Besides, it is worth remembering that efficiency and reliability of the entire plant system also depends on the performance of these motors, and that a motor default is the primary cause of the block of pumps or fans in buildings.

AC vs EC motor

Comparative case study with a centrifugal backward-curved motor-impeller.

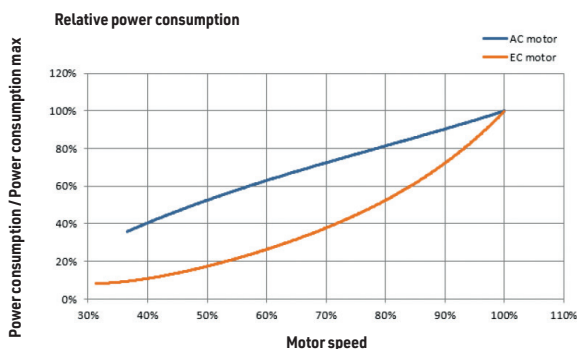

Savings in electricity consumption with an EC motor regulated at 40% of the maximum speed is about 70% according to a traditional AC motor.

THE SOLUTION

EC brushless motors: recent technological improvements applied to electric motors have introduced also in the HVAC industry a **new type of more performing engines.**

These motors are permanent magnet driven by sophisticated electronics without brushes and they do not need sliding electrical contacts.

Their main advantages over conventional AC motors are:

- Superior energy efficiency (50%)
- **Lower operating costs**
- **Low noise level**
- Precise speed control and adjustment
- **Superior aeraulic performances**
- Electronic protection integrated in the motor

The use of fans with EC motors can help reducing of at least 35% the energy consumption required for the ventilation.

Example of specific absorbed power

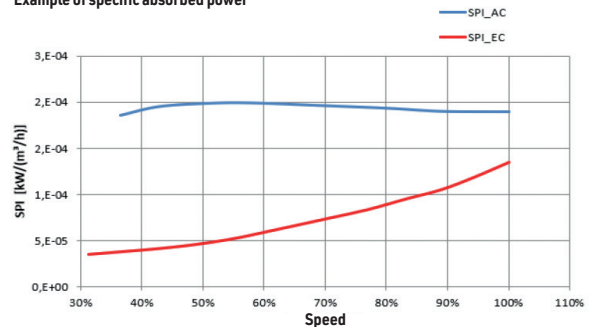

Specific absorbed power (SPI): here intended as the ratio between the effective absorbed power (expressed in kW) and the aspirator flow rate (expressed in m³/h). Example: with regulation at 70% of the maximum speed, SPI with motor EC = 0.00007 kW (m³/h), SPI with AC motor = 0.0002 kW (m³/h)



Complies with ErP Directive 2009/125/CE and UE Regulation 1253/2014
Classification: Residential Ventilation Unit



PERFORMANCE

OUTLET DIAMETER	SPEED	A	POWER	AIR FLOW	l/s	PRESSURE	LpA@3m
			W	m ³ /h		Pa	dB(A)*
80	Max	0,034	3,6	65	18	50	29
	Medium	0,020	1,9	41	11	21	19
	Min	0,015	1,1	21	6	7	14
100	Max	0,034	3,6	104	29	53	30
	Medium	0,020	1,9	67	19	23	20
	Min	0,015	1,1	33	9	7	14
120	Max	0,035	3,8	129	36	59	28
	Medium	0,020	1,9	81	22,5	25	17
	Min	0,014	1,1	41	11	8	14

* Sound pressure calculated @ 3m in free field - Performance measured at 230V / 50 Hz

- Modular axial fan provided with 3 outlet spigots of Ø80 - Ø100 - Ø120 mm
- Suitable for axial flow discharge towards the outside or through short ducts.
- Versatile installation on wall or ceiling.
- Very compact sizes and ultra-slim profile (33 mm without spigot), available with fixed grill.
- Integrated smart functions settable and controllable on board or via remote control according to versions.
- **Multi tension 100-240V 50-60Hz** ball bearing electronically commutated motor.
- Made of high quality antistatic technopolymer material.
- Optimized aerodynamic and fluid dynamic design.
- Impeller provided with an antivibration gasket.
- Aesthetic and smart LED on the cover with changing colors according to the ventilation modality.
- Back-draught shutters available on spigots (Ø 100 and 120).
- In compliance with EN 60335-2-80, EMC Directive 2014/30/EU, LVD Directive 2014/35/EU.

CURVES

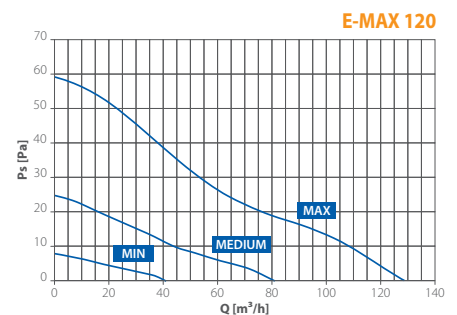
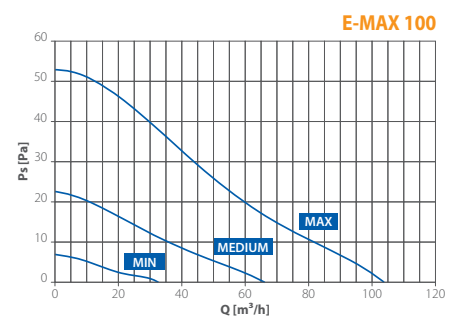
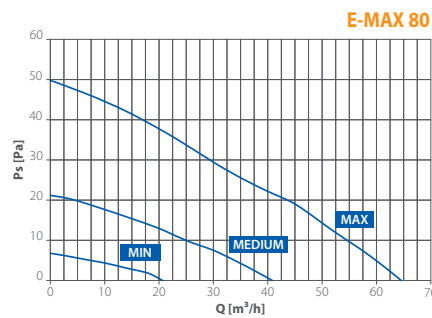

SUPPLIED

REMOTE CONTROLLER INCLUDED WITH e max PLUS RC



VERSIONS

STANDARD - On/Off via control switch (light or remote)

2V DT - 24 hours running at low speed (selectable between 2 at installation). Speed boosts to maximum via control switch (light or remote). The maximum speed is provided with a timer (adjustable from 0 to 30 minutes) which activation can be delayed up to 2 minutes to avoid unnecessary night-time operation at the highest speed. (DT/Delay Timer function, selectable at installation).

MHY - 24 hours running at low speed (not selectable). Speed boosts to maximum automatically or manually:

- **Automatically** via humidistat (adjustable from 45 to 85% of R.H). The fan speed increases/decreases according to the humidity level detected above the pre-selected threshold. It then switches back to the minimum speed when the humidity level goes beneath the pre-selected threshold and once concluded the pre-selected overrun via timer (adjustable from 0 to 30 min).

- **Manually** via control switch (light or remote). The fan boosts to maximum via the manual switch and goes back to the low speed once concluded the pre-selected overrun via timer (adjustable from 0 to 30 min).

PLUS - 24 hours running with minimum and maximum speeds both adjustable. The operation is similar to the MHY version. In addition, the fan is provided with the DT/ Delay Timer function (see E max 2V DT).

PLUS RC - This version is similar to the e max Plus one. In addition, it is supplied with a remote control from which it is possible to set 2 additional functions:

- an intermediate speed which will adjust automatically according to the minimum and maximum speeds selected.
- a sleep mode function that excludes the timer and humidistat functions for a period of 8 hours, preventing night disturbance.



PERFORMANCE

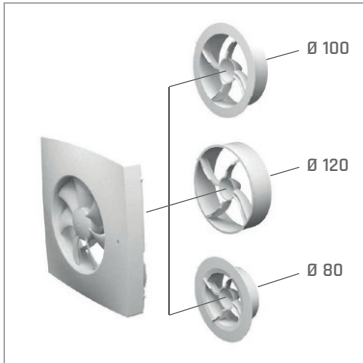

INTERCHANGEABLE OUTLET SPIGOTS

@max is supplied with 3 interchangeable spigots of \varnothing 80, 100 and 120 mm, replaceable with a click, for an easy and quick installation on any standard air duct sizes.



SILENT AND HIGHLY EFFICIENT IMPELLER

The advanced aerodynamic design of the impeller, which is also provided with an antivibration gasket, combines high airflow capacity and the lowest noise level between, 15 and 29 dBA at the maximum performance.



DETACHABLE MOTOR-IMPELLER

The frame is featured with a quick connection in order to facilitate and speed up the fan installation or maintenance without the use of tools.



INTEGRATED SERVICE SWITCH

@max is equipped with an integrated on/off slide switch to ease the maintenance operation.



INTEGRATED SMART FUNCTIONS

@max is provided with different integrated smart functions which optimize its operation and reduce the energy consumption.



OPTIMIZED EFFICIENCY

@max outlet spigots are provided with deflectors, optimized through a Computational Fluid Dynamic (CFD) analysis, to ensure a maximized efficiency.

DIMENSIONS (mm)

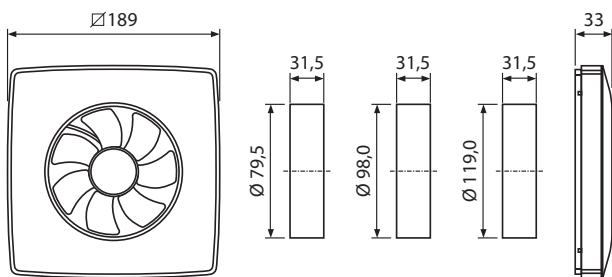

INSTALLATION

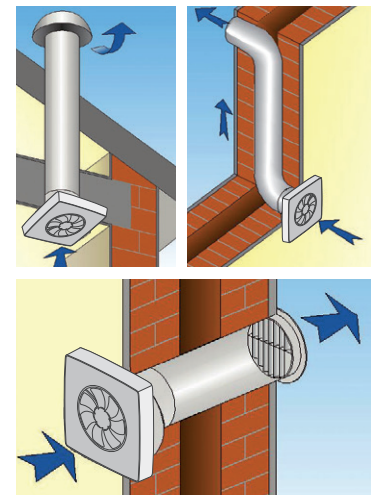



ELEGANCE EC 2V



Wall Axial fans
Linea Design EC versions



Complies with ErP Directive 2009/125/CE and EU Regulation 1253/2014
Classification: Residential Ventilation Unit



PERFORMANCE

MODEL	m ³ /h	l/s	Pa	W	dB(A)*
EC 2V					
Elegance 100 EC 2V	97 / 49 / 30	27 / 14 / 8	34 / 10 / 4	3,5 / 0,8 / 0,5	32 / 16 / 15
Elegance 100 EC DT 2V	97 / 49 / 30	27 / 14 / 8	34 / 10 / 4	3,5 / 0,8 / 0,5	32 / 16 / 15
Elegance 100 EC HDT 2V	97 / 49 / 30	27 / 14 / 8	34 / 10 / 4	3,5 / 0,8 / 0,5	32 / 16 / 15
Selv 12V - DC - Selv 2v					
Elegance 100 EC 2V 12V	81 / 49 / 30	22,5 / 14 / 8	24 / 10 / 4	2 / 0,8 / 0,5	32 / 16 / 15
Elegance 100 EC DT 2V 12V	81 / 49 / 30	22,5 / 14 / 8	24 / 10 / 4	2 / 0,8 / 0,5	32 / 16 / 15
Elegance 100 EC HT DT 2V 12V	81 / 49 / 30	22,5 / 14 / 8	24 / 10 / 4	2 / 0,8 / 0,5	32 / 16 / 15

* Lp(A) measured at 3m in open field 230V-50Hz.

- Energy efficient EC motor.
- Choice of 2 low speeds at installation.
- Provides low level continuous ventilation to control condensation.
- For any domestic wet room.
- Low noise levels and running costs.
- Wall, ceiling or window (with additional window kit) installation.
- Exhausts directly to the outside (through wall, or window installation with additional window kit, or with medium length ducting - up to 6m)
- Runs continuously at pre-selected choice of two speeds (fixed at installation)
- Patented anti-turbulence deflectors ensure very low noise levels and optimum performance
- Energy saving ventilation
- Extremely low running costs

CURVES

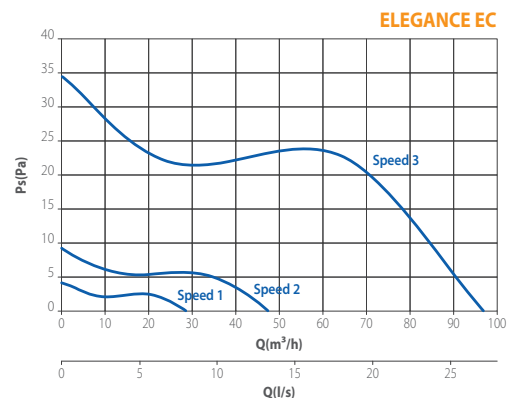

DIMENSIONS (mm)

MODEL	A	ØB	C	D	Kg
ELEGANCE 100 EC 2V	160	98	80	38	0,9

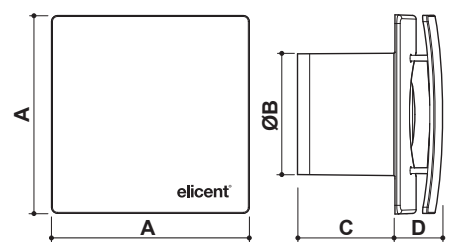

INSTALLATION

WALL

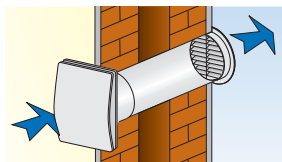

CEILING

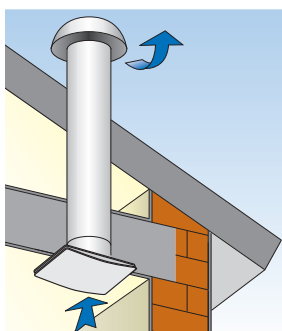

VERSIONS

EC 2V DT - 24 hours running at low speed (selectable between 2 at installation). Speed boosts to maximum via control switch. The maximum speed is provided with a timer (adjustable from 0 to 30 minutes) which activation can be delayed up to 2 minutes to avoid unnecessary night-time operation at the highest speed. (DT option, selectable at installation).

EC 2V HDT - 24 hours running at low speed (selectable between 2 at installation). Speed boosts to maximum automatically and/or manually:
- automatically via humidistat (adjustable from 40 to 90% of R.H). The fan switches back to the low speed when the humidity level goes beneath the pre-selected threshold and once concluded the pre-selected overrun via timer (adjustable from 0 to 30 min).
- manually via control switch (remote or pull cord). The fan switches back to the low speed once concluded the pre-selected overrun via timer (adjustable from 0 to 30 min). The activation of the timer can be delayed up to 2 minutes to avoid unnecessary night-time operation at the highest speed. (DT option, selectable at installation).

All EC models (100 2 speed, 2V DT, 2V HDT) are also available in SELV version, low voltage 12V.

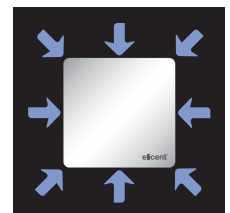

Lateral intake on the whole perimeter



ELIX EC 2V

Centrifugal duct fan
Linea Design EC versions



Complies with ErP Directive 2009/125/CE
and EU Regulation 1253/2014
Classification: Residential Ventilation Unit

- Energy efficient EC motor
- Provides low level continuous ventilation to control condensation
- Choice of 2 low speeds at installation
- For wall or ceiling installation
- For any domestic wet room
- Low noise levels and running costs
- Exhausts directly to the outside or through long lengths of ducting (up to 15m)
- Runs continuously at pre-selected choice of two speeds (fixed at installation).
- Anti-vibration gasket.
- Easily removable, washable polypropylene filter.
- Energy saving ventilation.
- Extremely low running costs.
- Low carbon footprint.

INSTALLATION

SINGLE DUCT

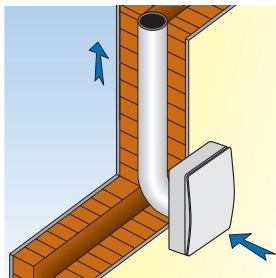

MULTIPLE DUCT

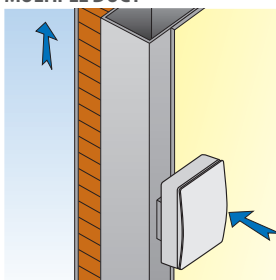

PERFORMANCE

MODEL	DUCT Ø	m³/h	l/s	Pa	W	dB (A)*
ELIX 100 EC 2V	100	100 / 46 / 32	28 / 13 / 9	200 / 44 / 23	15 / 2,4 / 1,6	37 / 18 / 16
ELIX 100 EC 2V DT	100	100 / 46 / 32	28 / 13 / 9	200 / 44 / 23	15 / 2,4 / 1,6	37 / 18 / 16
ELIX 100 EC 2V HDT	100	100 / 46 / 32	28 / 13 / 9	200 / 44 / 23	15 / 2,4 / 1,6	37 / 18 / 16

* Lp(A) measured at 3m in open field 230V-50Hz.

CURVES

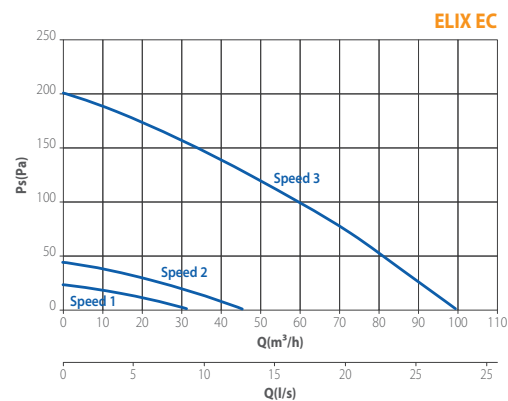

DIMENSIONS (mm)

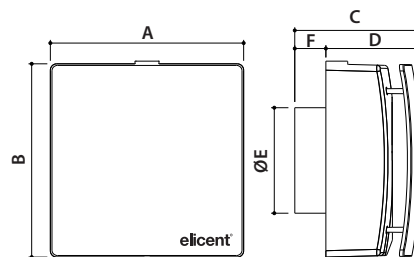

MODEL	A	B	C	D	E	F	Kg
ELIX 100 EC 2V	180	180	116	87	99	29	2,6

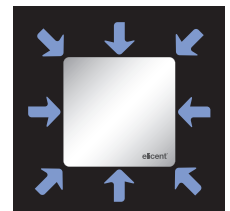

Lateral intake on the whole perimeter



Sliding filter

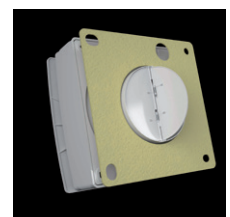

Antivibration gasket

VERSIONS

EC 2V DT - 24 hours running at low speed (selectable between 2 at installation). Speed boosts to maximum via control switch. The maximum speed is provided with a timer (adjustable from 0 to 30 minutes) which activation can be delayed up to 2 minutes to avoid unnecessary night-time operation at the highest speed. (DT option, selectable at installation).

EC 2V HDT - 24 hours running at low speed (selectable between 2 at installation). Speed boosts to maximum automatically or manually:
- automatically via humidistat (adjustable from 40 to 90% of R.H). The fan switches back to the low speed when the humidity level goes beneath the pre-selected threshold and once concluded the pre-selected overrun via timer (adjustable from 0 to 30 min).
- manually via control switch (remote or pull cord). The fan switches back to the low speed once concluded the pre-selected overrun via timer (adjustable from 0 to 30 min). The activation of the timer can be delayed up to 2 minutes to avoid unnecessary night-time operation at the highest speed. (DT option, selectable at installation).

All EC models (100 2V, 2V DT, 2V HDT) are also available in SELV version, low voltage 12V.



EXT EC

Centrifugal fans for outdoor installation



Complies with ErP Directive 2009/125/CE and UE Regulation 1253/2014.

EXT 100 EC - Residential Ventilation Unit.
EXT 125-150-160-200 EC
Non Residential Ventilation Unit.

- High performance and high efficiency centrifugal fans for outdoor installation
- Easy and cost-effective solution for a centralized ventilation requirement
- Complete range: 5 models available in sizes Ø 100 to 200 mm
- Ideal solution in environments where aesthetics, space or noise level are of concern
- Steel housing with epoxy finish highly resistant to atmospheric agents
- Suitable for clean air at max temperature of +60°C
- Provided with an external protection net and a gravity shutter to prevent the entry of wind, insects, sand etc.
- Ball bearing EC motor and backward curved blades
- Impeller in technopolymer. Statically and dynamically balanced according to ISO 1940
- Suitable for continuous running
- Speed controllable



PERFORMANCE

MODEL	m³/h	l/s	Pa	W	A	LwA dB(A)**	LpA
EXT 100 EC*	298	83	713	78	0,7	71	50
EXT 125 EC	471	131	668	85	0,77	70	50
EXT 150 EC	564	157	570	89	0,79	75	55
EXT 160 EC	723	201	484	89	0,79	68	48
EXT 200 EC	902	251	567	170	1,5	75	54

* ERP 2018 specifications: models to be installed preferably in conjunction with a local regulation EC kit
**LWA: sound power according to ISO 3746 / LPA: sound pressure at 3 m in open field (inlet side)

CURVES

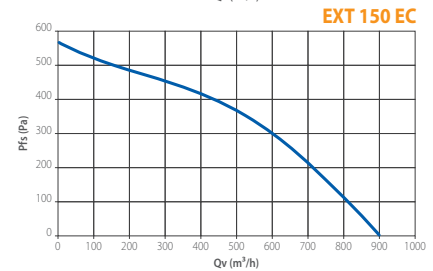
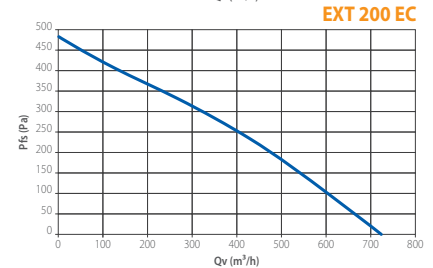
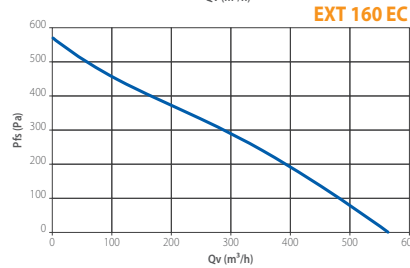
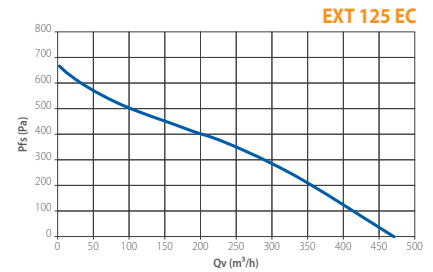
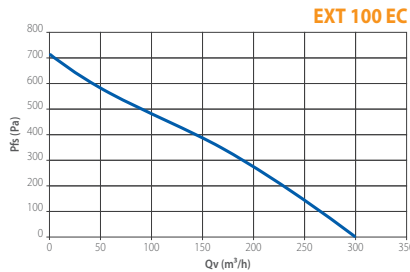

DIMENSIONS (mm)

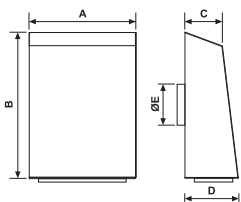

MODELS	A	B	C	D	ØE	Kg
EXT 100 EC	260	355	92	131	98	4,8
EXT 125 EC	260	355	92	131	122	4,8
EXT 150 EC	260	355	92	131	148	5
EXT 160 EC	260	355	92	131	158	5
EXT 200 EC	360	450	116	155	198	7,4

INSTALLATION

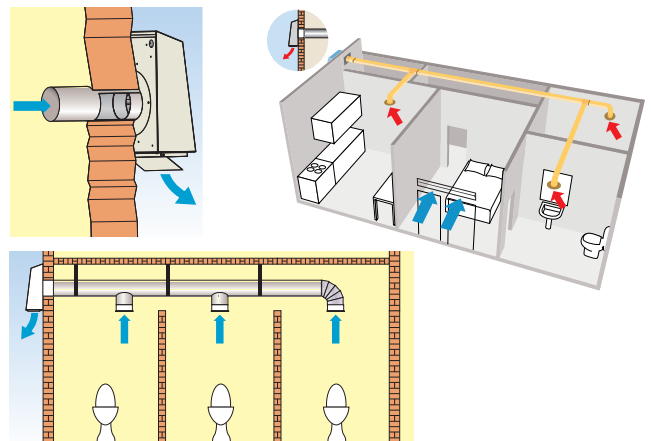

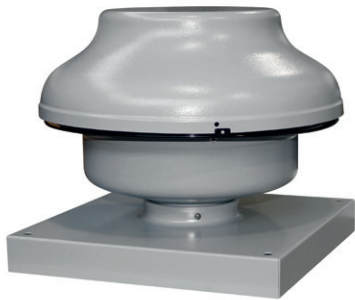

Complies with ErP Directive 2009/125/CE and UE Regulation 1253/2014 Non Residential Ventilation Unit

- High performance and high efficiency centrifugal fans for roof installation
- Easy and cost-effective solution for a centralized ventilation requirement
- Complete range: 7 models available in sizes Ø100 to 315 mm
- Compact sizes
- Available with square roof curb
- Made in aluminium and steel sheet with epoxy finish highly resistant to atmospheric agents.
- Suitable for clean air at max temperature of +60°C
- Ball bearing EC motor and backward curved blades
- Impeller in technopolymer. Statically and dynamically balanced according to ISO1940
- Suitable for continuous running
- Speed controllable

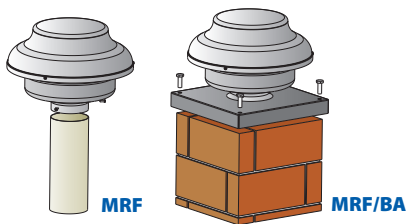

- MRF
- MRF-BA with square roof curb

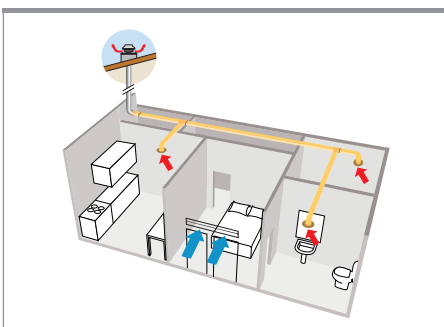

PERFORMANCE

Model	m³/h	l/s	Pa	W	A	LwA dB(A)*	LpA
MRF 100 EC	395	110	765	78	0,70	77	56
MRF 125 EC	431	120	720	75	0,70	77	56
MRF 150 EC	608	169	518	78	0,70	73	53
MRF 160 EC	682	189	524	85	0,77	72	52
MRF 200 EC	745	207	538	85	0,77	68	48
MRF 250 EC	725	201	495	85	0,77	70	49
MRF 315 EC	1.184	329	607	175	1,50	74	53

* LWA: sound power according to ISO 3746 / LPA: sound pressure at 3 m in open field (inlet side)

DIMENSIONS (mm)

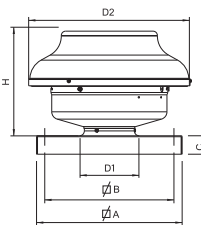

MODELS	D1	D2	H	∅A	∅B	C	Kg	Kg*
MRF 100 EC	98	333	225	300	265	36	3,1	4,6
MRF 125 EC	122	333	225	300	265	36	3,1	4,6
MRF 150 EC	147	405	266	400	360	36	4,2	6,2
MRF 160 EC	157	405	266	400	360	36	5	6,2
MRF 200 EC	198	405	266	400	360	36	5,5	6,8
MRF 250 EC	248	405	266	400	360	36	6	7,3
MRF 315 EC	314	484	322	400	360	36	7	10

* Models with square roof curb

CURVES

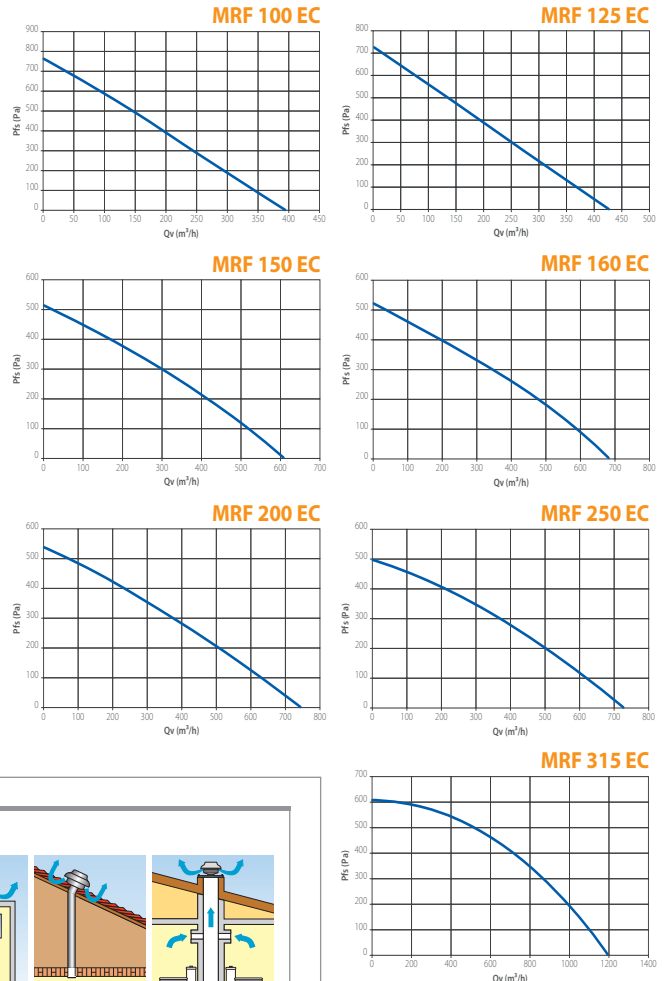

INSTALLATION

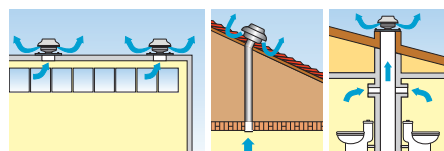



Complies with ErP Directive 2009/125/CE and UE Regulation 1253/2014

AXC 100-125-150 EC:
Residential Ventilation Unit

AXC 160-200-250-315 EC:
Non Residential Ventilation Unit

- High performance and high efficiency centrifugal fans for in-line duct installation.
- Easy and cost-effective solution for a centralized ventilation requirement.
- Complete range: 7 models available in sizes \varnothing 100 to 315 mm.
- Vertical or horizontal installation.
- Steel housing with epoxy finish inside and outside.
- Supplied with wall fixing brackets.
- Suitable for clean air at max temperature of $+60^{\circ}\text{C}$
- Ball bearing EC motor and backward curved blades provided with air rectifiers.
- Impeller in technopolymer. Satically and dynamically balanced according to ISO 1940.
- Suitable for continuous running.
- Speed controllable.

SUPPLIED

Wall fixing brackets

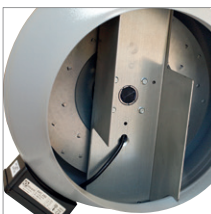
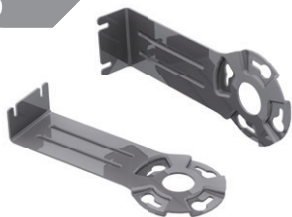

Air rectifiers



Backward curved blades



PERFORMANCE

Model	m ³ /h	l/s	Pa	W	A	dB(A)**
AXC 100 EC *	320	89	673	77	0,7	39
AXC 125 EC *	403	112	626	77	0,7	39
AXC 150 EC *	481	134	505	77	0,7	39
AXC 160 EC	695	193	471	85	0,8	33
AXC 200 EC	866	241	461	85	0,8	37
AXC 250 EC	855	238	438	85	0,8	35
AXC 315 EC	1300	361	584	175	1,5	38

* ERP 2018 specifications: models to be installed preferably in conjunction with the local regulation EC kit.

** Sound pressure level calculated at 3m free field

DIMENSIONS (mm)

TIPO	A	B	C	$\varnothing D$	$\varnothing d$	E	Kg
AXC 100 EC	12	215	24	245	98	38	3
AXC 125 EC	11	215	24	245	122	38	3
AXC 150 EC	21	216	23	245	147	38	3
AXC 160 EC	21	230	22	333	158	38	5
AXC 200 EC	22	230	27	333	198	38	5
AXC 250 EC	22	230	35	333	248	38	5
AXC 315 EC	30	297	52	404	314	38	8

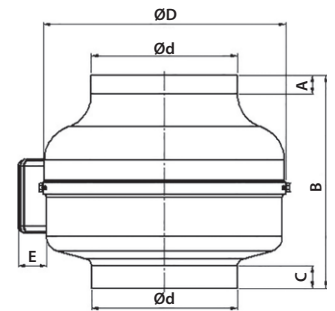

INSTALLATION

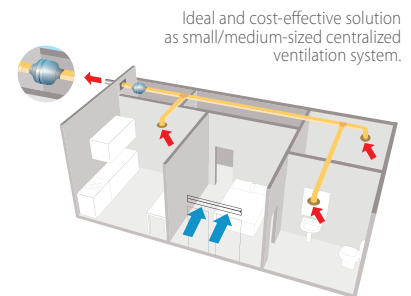
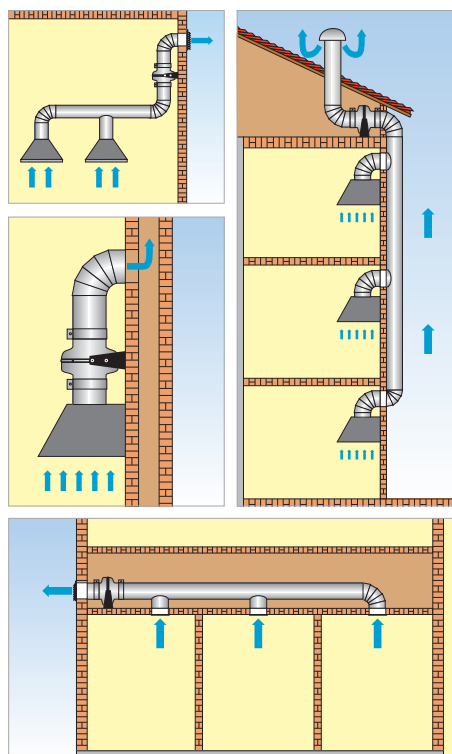

Ideal and cost-effective solution as small/medium-sized centralized ventilation system.



CURVES

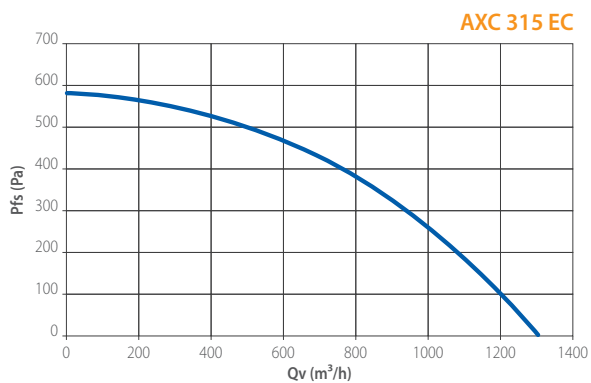
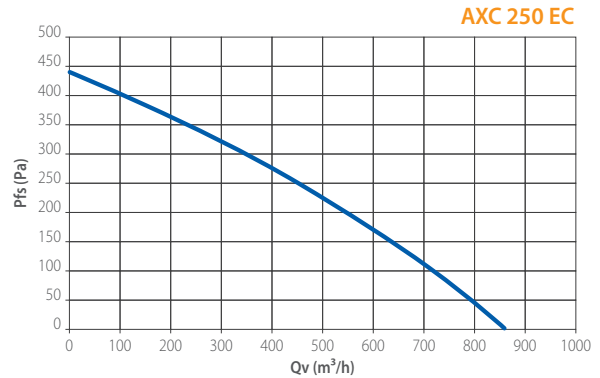
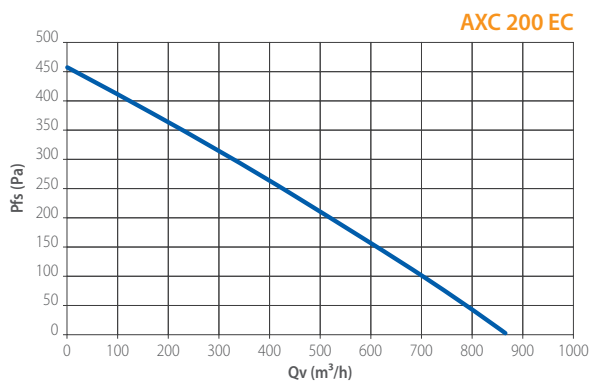
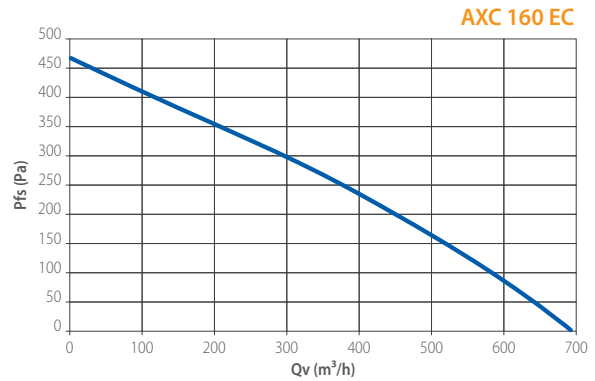
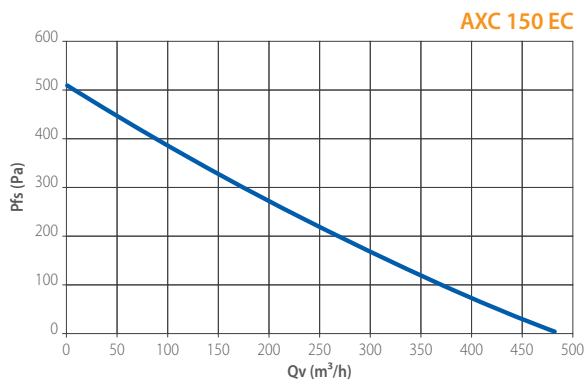
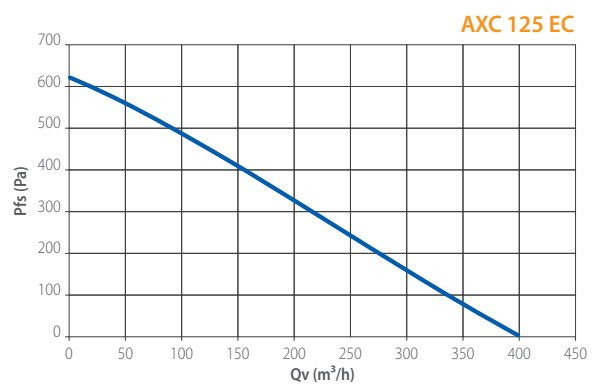
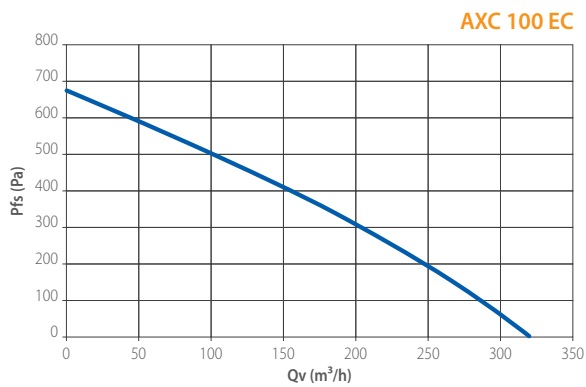

AIR CURTAINS

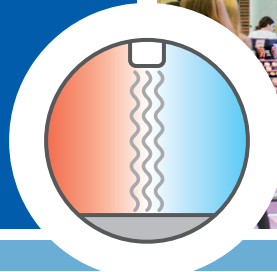

PRINCIPLE

In buildings where the **entrance doors are continuously opened and closed it is useful to block the inflow of undesired outdoor air** during the winter period and to protect indoor spaces from warm air entering during the summer period. In fact, due to the temperature difference that is generated, **there is a progressive loss of power in the temperature control system**, as well as notable humidity imbalances and discomfort for the public, which reduces their time spent in the establishment.

Furthermore, in commercial places with a high customer inflow and rotation, **the presence of traditional entrance doors may constitute a psychological barrier for the customers**, which operators obviously wish to avoid (such as department stores, supermarkets, bars, restaurants, boutiques).

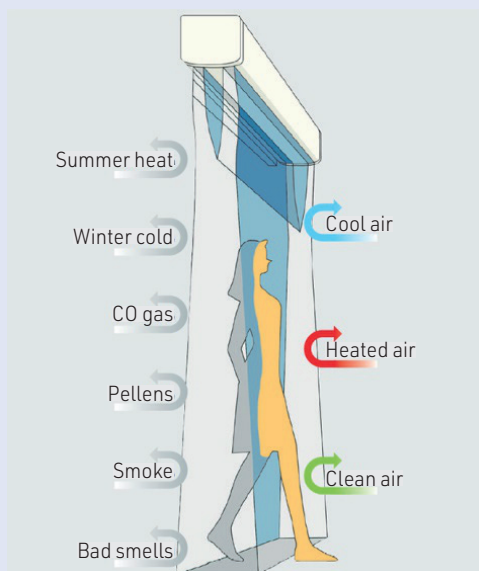

BENEFITS

To obtain a notable energy saving, keeping warm or cool air inside commercial and non-commercial premises, and contribute to making the indoor air healthier by not allowing smog, unpleasant odours, dust, pollen and insects to enter, air curtains come into play.

Air curtains are devices that enable the formation of an invisible vertical wall of air between the indoor area of premises (generally heated or air conditioned) and outdoors, without limiting access by people or vehicles. Depending on the season, the air is mixed in different temperatures and at different supply speeds, in order to reach the optimal conditions for people to pass through. For this reason they are particularly suited to being used in commercial locations, such as department stores, bars and shops, located either inside or outside of shopping centres, and in places where time that the doors are open is particularly significant for the indoor air conditioning systems (receptions, warehouses, gyms).

The protection offered to the environment enables customers to enter and exit at will, without impeding their path and also maximising visibility of the environment while increasing indoor comfort.

Maico Italia - Elicent® air curtains:

- ELDOOR TZ - Tangential
- ELDOOR CF - Centrifugal

are the most innovative and easy to install product on the market to create situations of safe wellbeing and energy saving, drastically reducing energy consumption for heating and cooling, while also protecting the quality of the indoor air.



ELDOOR TZ



Tangential air curtains



FEATURES

- 3 sizes: 90, 120 or 150 cm width
- Air velocity 11 m/s
- Installation height: 2,3÷3 m
- Stainless steel and varnished metal housing
- Can be coupled with the door magnetic contact (supplied as accessory) for automatic on/off running
- 2 speeds (with LED signal)
- Remote controller supplied
- Single-phase power supply
- Airflow orientation through deflectors
- High efficiency and silent running
- Easy to install thanks to the fixing bracket (included)
- Inlet front side allows an installation close to the ceiling (min. distance 30 cm)
- Supplied with connexion cable and plug (TYPE L, 3 poles, 10A)

SUPPLIED



REMOTE CONTROLLER

PERFORMANCE

CODE	UNIT OF MEASUREMENT	MODELS		
		ELDOOR 900 TZ 4BA0000	ELDOOR 1200 TZ 4BA0001	ELDOOR 1500 TZ 4BA0002
Voltage - Frequency	V - Hz	230-50	230-50	230-50
Size (Width)	cm	90	120	150
Impeller diameter	mm	120	120	120
Installation height	m	2,3 - 3	2,3 - 3	2,3 - 3
Electric power	W	150	180	220
Air velocity	m/s	11	11	11
Airflow	m ³ /h	1200	1700	2100
Sound levels	db(A)	45	47	47
Dimensions (L x h x w)	mm	900x220x195	1200x220x195	1500x220x195
Weight	kg	13	16	20



ELDOOR CF



Centrifugal air curtains



FEATURES

- 3 sizes: 90, 120 or 150 cm width
- Air velocity 14,5 m/s
- Installation height: 3÷3,5 m
- 2 speeds (with LED signal)
- Remote controller included
- Single-phase power supply
- Stainless steel and varnished metal housing
- Airflow orientation through deflectors
- Can be coupled with the door magnetic contact for automatic on/off running (supplied as accessory)
- High efficiency and silent running
- Easy to install thanks to the fixing bracket (included)
- Inlet front side allows an installation close to the ceiling (min. distance 30 cm)
- Supplied with connexion cable and plug (TYPE L, 3 poles, 10A)

SUPPLIED



REMOTE CONTROLLER

PERFORMANCE

CODE	UNIT OF MEASUREMENT	MODELS		
		ELDOOR 900 CF 4BA0010	ELDOOR 1200 CF 4BA0011	ELDOOR 1500 CF 4BA0012
Voltage - Frequency	V - Hz	230-50	230-50	230-50
Size (Width)	cm	90	120	150
Impeller diameter	mm	120	120	120
Installation height	m	3,0 - 3,5	3,0 - 3,5	3,0 - 3,5
Electric power	W	220	275	330
Air velocity	m/s	14,5	14,5	14,5
Airflow	m ³ /h	1020	1360	1700
Sound levels	db(A)	44	45	48
Dimensions (L x h x w)	mm	960x230x212	1200x230x212	1500x230x212
Weight	kg	16	19	24

HEATING



PRINCIPLE

Temperature is one of the main factors that determine man's wellbeing in confined spaces. However, there are situations in which a permanent heating system is not provided or required, both due to the type and the frequency of use of the room. In these cases, it is essential to guarantee people's thermal comfort with versatile heating systems that can be used in any location and/or at any time, whether residential or industrial.

BENEFITS

Electrical heating meets this requirement and also has the important advantage of not resulting in gas emissions, in particular carbon dioxide.

It is technically simpler than gas heating and easily lends itself to being managed automatically and the commissioning costs for electrical heating are considerably lower.

From the point of view of the urban environment, for safety, versatility and comfort there is nothing better than warming yourself up with electricity: no fumes, no risk of explosions or toxic gases, no maintenance, very quick installation, highly responsive and the possibility to adjust the heating with precision over time and space:

- The industrial convection heaters of the VOLCANO R and PRO Series and residential convection heaters of the CALDO Series from Maico Italia- Elicent® create heat quickly and do not require particular maintenance. They offer ease of transport and can be adjusted/programmed.

- The infrared lamps of the CALDO Series from Maico Italia - Elicent® transmit heat uniformly into the surrounding environment, keeping the relative humidity constant in all of the environment, thereby promoting thermal wellbeing; all of this in just a few moments, without noise, and obviously with light radiation. In this way it is possible to obtain more pleasant heating at a relatively low environmental temperature, with energy savings too.



CALDO 500



Residential



- Antifreeze heater for wall installation
- Adjustable ambient thermostat
- Provided with Schuko plug
- Armored resistance

PERFORMANCE

MODEL	V at 50 Hz	W max	IP	DIMENSIONS (cm)	WEIGHT (Kg)
CALDO 500	230V	500W	IP21	24 x 10,5 x 24	0,95

INSTALLATION

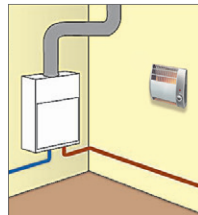

Technical premise



Toilet



CALDO BAGNO 2000



Residential



- Compact and oscillation heater 24h programmable (with intervals of 30 minutes)
- 4 position switch: Off / cold air / Hot air 1000W / Very hot air 2000W
- Adjustable ambient thermostat
- Body in self-extinguishing plastic material
- Double insulation
- Protection IP21
- Heated area: 20 m²

PERFORMANCE

MODEL	V at 50 Hz	W max	DIMENSIONS (cm)	WEIGHT (Kg)
CALDO BAGNO 2000 TP	220-240 V	2.000 W	24,5 x 36,6 x 19	1,78



Right / Left oscillation



24h programmable





CALDO LAMP 1500 GOLD



Residential



- Radiant heater for indoor and outdoor use
- Halogen golden resistance of 1500W
- Body in aluminium
- 0/1 pull cord switch
- Provided with wall fixing kit
- IP55 protection heated area: 15 m²

PERFORMANCE

MODEL	V at 50 Hz	W max	DIMENSIONS (cm)	WEIGHT (Kg)
CALDO LAMP 1500 GOLD	220-240V	1.500 W	45,5 x 10 x 22,5	1.6

SUPPLIED



Supporto murale orientabile alto/basso 90°.

SPARE PART

Infrared lamp



CALDO LAMP 1500



Residential



- Radiant heater for indoor and outdoor use
- 3 quartz heaters of 1500W (500+500+500)
- Pull cord selection switch
- Wall fixing bracket offering 4 orientations
- Body in steel sheet, front cover in silver paint
- IP24 protection
- Heated area: 18 m²

PERFORMANCE

MODEL	V at 50 Hz	W max	DIMENSIONS (cm)	WEIGHT (Kg)
CALDO LAMP 1500	220-240V	1.500 W	56 x 16,5 x 12	1,8

High / Medium / Low adjustment and fixing kit supplied



HIGH



MEDIUM



LOW

SPARE PART

Halogen lamp





CALDO TURBO 2000 TECH



Residential



Remote controller supplied



PERFORMANCE

MODEL	V at 50 Hz	W max	DIMENSIONS (cm)	WEIGHT (Kg)
CALDO TURBO 2000 TECH	220-240	2.000 W	68,3 x 41,2 x 18	4,4

FEATURES

- Convector heater using natural convection
- Electronic control and remote controller to activate the stand-by function and the ventilation level (3 settings: Eco 750W / Comfort 1250 W / Rapid 2000W)
- Antifreeze function
- Temperature regulation: 5~37°C
- Turbo function to direct the heat flow towards
- Programmable timer up to 15 hours
- Backlit display in blue which shows the selected functions and the ambient temperature
- Anti-tip switch
- Integrated side handles
- Body in painted steel
- Double insulated
- IP20 protection
- Heated area: 20 m²



CALDO TURBO / CALDO 2000



Residential



CALDO 2000



PERFORMANCE

MODEL	V at 50 Hz	W max	DIMENSIONS (cm)	WEIGHT (Kg)
CALDO 2000	220-240	220-240	58,7 x 42,3 x 19 x 8	3
CALDO TURBO 1000	220-240	1.000 W	58,7 x 42,3 x 19 x 8	3
CALDO TURBO 1500	220-240	1.500 W		3
CALDO TURBO 2000	220-240	2.000 W		3
CALDO TURBO 2000 TIMER	220-240	2.000 W		3

FEATURES

- Convector heater using natural convection
- Model CALDO TURBO provided with a frontal grille to direct the heat flow forward
- Adjustable ambient thermostat
- Antifreeze function
- Can be wall-mounted (wall installation kit supplied)
- Body in painted steel
- Double insulated
- IP20 protection
- Heated area: 20 m²

Range:

- CALDO 2000: one model including 3 heating levels: 750 / 1250 / 2000W
- CALDO Turbo: 3 models with 3 heat setting each: Caldo Turbo 1000: 350 / 650 / 1000W Caldo Turbo 1500: 500 / 1000 / 1500W Caldo Turbo 2000: 750 / 1250 / 2000W



VOLCANO R



Industrial



PERFORMANCE

MODEL	V at 50 Hz	kW		A	DIMENSIONS L x p x h	WEIGHT (Kg)
		MIN	MAX	MAX		
VOLCANO R 3300	230	1,63	3,3	14,3	250 X 250 X420	7,5
VOLCANO R 5000	400	2,5	5	7,2	250 X 250 X420	8

FEATURES

- Heaters ideally suited for heating small and medium sized industrial premises
- Manufactured in rugged steel cabinet with strong safety insulated handles
- Encapsulated stainless steel heating elements that are extra-insulated from the cabinet
- Provided with safety thermostat which guards against overheating and ensures that fire hazard does not arise
- 2 models: 3,3 or 5 kW
- Provided with room thermostat to maintain the desired temperature
- Selectable heating effect, between 1/2 and 1/1 through the selector switch
- The 5 kW model is provided with a CEE plug of 16A, 5 poles, IP44 while the 3kW model is provided with a Schuko plug of 16A IP44.
- Supplied with wall mounting kit.

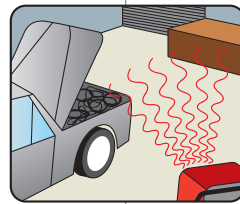
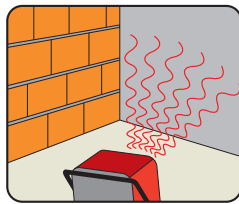
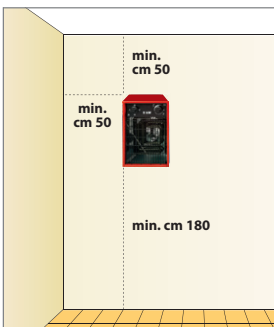

VOLCANO PRO



Industrial



PERFORMANCE

MODEL	V at 50 Hz	kW		A	m³/h	DIMENSIONS L x p x h	WEIGHT (Kg)
		MIN	MAX	MAX			
VOLCANO PRO 6000	400	3	6	10	1600	340 X 390 X 510	7
VOLCANO PRO 9000	400	4,5	9	13	1700	340 X 390 X 510	7,5

FEATURES

- Heaters ideally suited for heating medium sized industrial premises
- 2 models: 6 or 9 kW
- Very compact and unique dimension for both models
- Housing in steel sheet
- Provided with delay start and delay stop functions, settable on the panel
- Provided with a cooling down post ventilation function (max 10 minutes)
- Provided with a CEE plug of 16A, 5 poles, IP44
- Supplied with wall mounting kit

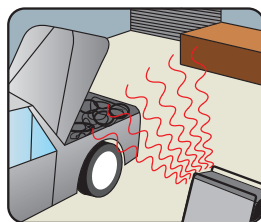
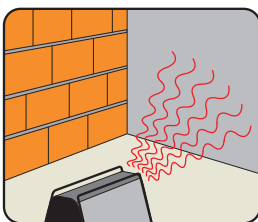

VENTILATION



PRINCIPLE

In winter, in heated environments, the less dense hot air tends to accumulate in upper areas due to convection while in summer the gas emissions linked to the large quantities of energy consumed by air conditioning systems require a more attentive and aware attitude towards the environment.

BENEFITS

Ceiling fans are an excellent solution for cooling and heating environments. In winter fans installed on the ceiling are able to destratify the warm air accumulated in the upper areas of the room and to distribute it homogeneously with a consequent energy recovery.

In summer it is not only a reduction in temperature that contributes to cooling but also optimal air circulation: a ceiling fan spinning at low speeds increases the sensation of coolness, makes the air more breathable and reduces the energy costs arising from excessive use of the air conditioning system.

Unlike air conditioners, ceiling ventilation does not alter the temperature and humidity present in the environment and, if used in combination, enables the cooling potential to be fulfilled, allowing the system to be switched on for a less period of time and therefore reducing electricity consumption. It is therefore a simple solution to the energy saving requirement in rooms, industrial or sports environments, and in commercial spaces:

MP800 destratifiers and POLAR reversible ceiling fans from Maico Italia - Elicent® meet these functionality requirements and are extremely easy to install.



POLAR EVOLUTION



Reversible ceiling fan



POLAR Evolution



POLAR Evolution with light kit

REVERSIBILITY
settable directly on the fan



SUPPLIED

Supplied with 45 cm rod



For indoor use only



PERFORMANCE

MODEL	DIAMETER (mm)	V at 50Hz	W	A	RPM	m³/h
POLAR EVOLUTION 90	900	230	65	0,25	390	5150
POLAR EVOLUTION 120	1.200	230	80	0,33	330	10.080
POLAR EVOLUTION 140	1.400	230	85	0,35	285	11.220
POLAR EVOLUTION 150	1.500	230	90	0,38	280	13.140

DIMENSIONS (mm)

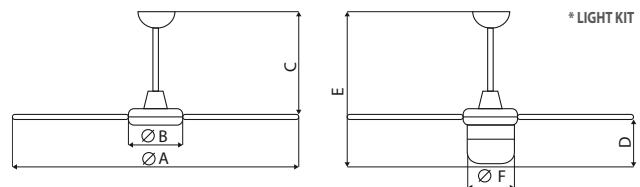

MODEL	ØA	ØB	C	D	E	ØF	Kg
POLAR EVOLUTION 90/36	900	200	530	150	680	190	5
POLAR EVOLUTION 120/48	1200	200	530	150	680	190	5,4
POLAR EVOLUTION 140/56	1400	200	530	150	680	190	5,6
POLAR EVOLUTION 150/60	1500	200	530	150	680	190	5,9

ACCESSORIES



Light kit



Remote controller and receiver kit



RVS PLUS EVO:
5 speed controller with on/off switch. Regulation up to 4 POLAR. Max load 1,5 A. IP 42 protection. Size 158x118x76 mm.



RVS/L 5 speed controller with on/off and light switch. Max load 0,5 A. IP42 protection. Size 118x118x58 mm.



30 and 90 cm rods

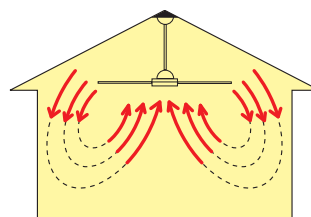

WINTER
indirect ventilation

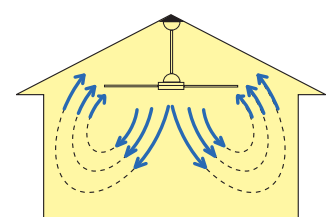

SUMMER
direct ventilation



MP800

Air Scatter



PERFORMANCE

MODEL	V	m ³ /h	KW	A	RPM	PROTECTION IP	dB (A) (at 6 m)	Kg
MP800 single-phase	230	11.000	0,18	1,54	700	55	66	22
MP800 three-phase	230 / 400	11.000	0,18	1,44 / 0,83	700	55	66	22

- Single (230V) or three-phase (400V) motors
- Supplied with ceiling fixing chains
- Ideal for large heated premises
- Each scatter covers an area of 200 m²

DIMENSIONS (mm)

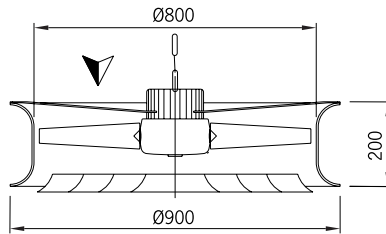

MODEL	Ø A	B	Ø C
MP800	915	180	800

INSTALLATION

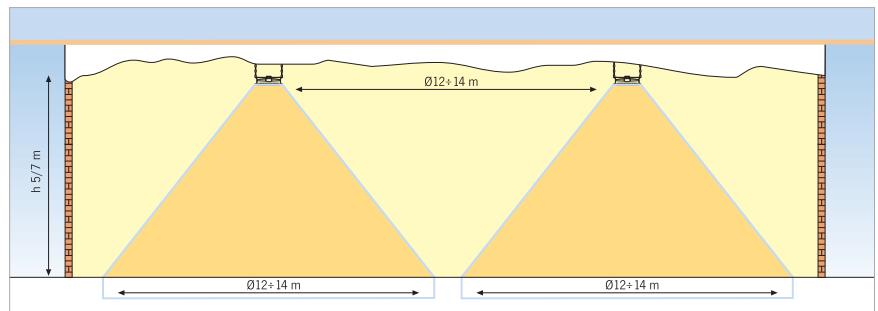

SUPPLIED

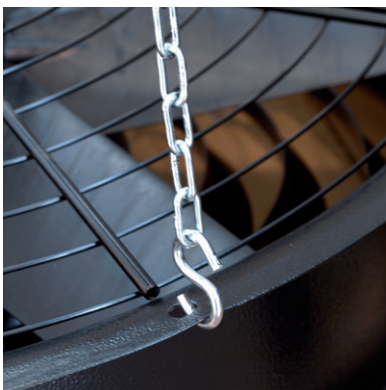

Chains for ceiling application

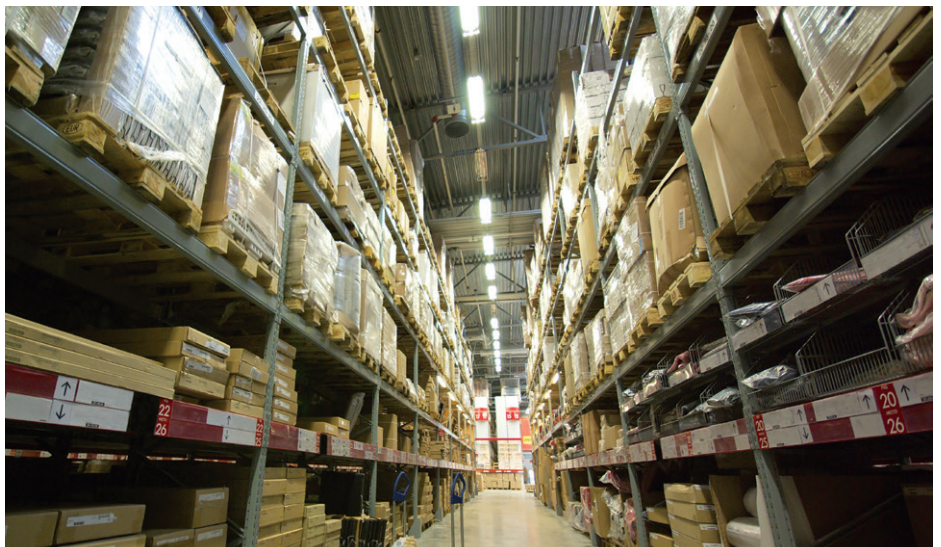

HYGIENE

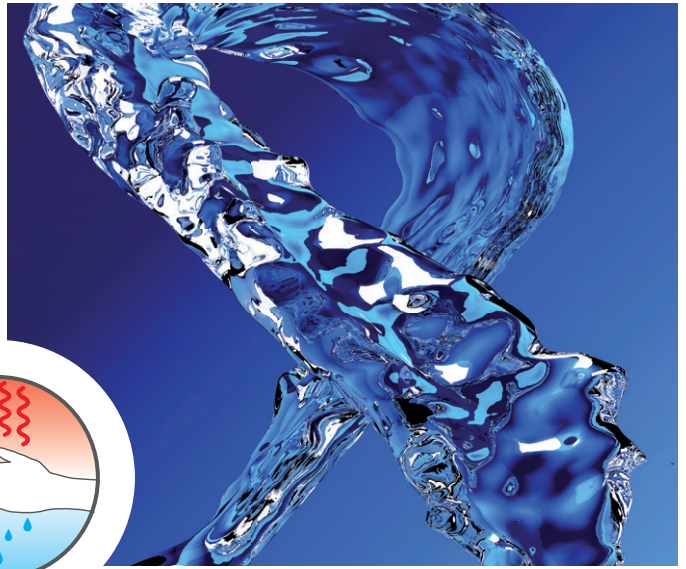

PRINCIPLE

The effectiveness of hand drying is an essential aspect for reducing the transmission of bacteria and other micro-organisms, as it is more likely to occur with wet skin than dry skin; in this respect certain studies have discovered that six times more bacteria grow on the surface of paper towel dispensers than on air-powered devices.

Paper towels are also systematically used in excess with consequent disposal and recycling expenses.

BENEFITS

Electric hand dryers and hair dryers offer the advantage of greater hygiene for the people using them, as direct contact is avoided and is replaced by a jet of hot air that is activated with a button or the photocell, drying the hands or hair while also giving a sensation of softness and cleanliness.

Their operation is ensured 24/7 and paper waste is avoided when using these devices instead.

Rooms in which they are installed are certainly cleaner and tidier, and for high-traffic areas they provide anti-theft and anti-vandalism peace of mind:

- In the next generation hand driers of the ECOJET Series from Maico Italia - Elicent® the jet of hot air is replaced with an air blade, which is much more powerful and comes out of several slots, ensuring quick drying in just 8 seconds; although the ECOFLOW Series has a traditional automatic functioning, being equipped with a high speed motor it ensures drying in just 12 seconds. Both series are free from electrical resistance and optimise electricity consumption, and are therefore particularly ecological

- The HD and HR Series from Maico Italia - Elicent® guarantee the advantages mentioned above and offer particular cost savings

THE ADVANCED QUALITY

7 Good reasons for choosing hand dryers as opposed to traditional drying systems

- 1 **24/7** automatic service.
- 2 No costs of buying, supplying and disposing of paper towels.
- 3 High waste reduction: paper is usually overused, hand dryers are used only for the necessary drying time.
- 4 Restrooms look cleaner and tidier.
- 5 Antivandal models available for high traffic zones.
- 6 Higher hygienic standards, lower bacterial proliferation in the bathroom.
- 7 **Optimized used of energy:** reduced waste and carbon footprint.



COVER WITH ANTI-VANDAL LOCK

Steel one-piece vandal-proof cover, extremely robust and impact-resistant. The cover can be locked and removed for cleaning with the special wrench supplied. The special finishing in white epoxy SCRATCH-RESISTANT PAINT is ideal for a long-lasting quality and an efficient cleaning (even from spray paints or marker pens).



UV STABILIZED

Made of UV resistant ABS plastic. Protected with anti-aging and fire-proof paint UL94-V0.



LOW NOISE

The noise levels are among the lowest in this category of high efficiency dryers. The wall fixing plates are provided with an anti-vibration gasket.



QUICK DRY

The high efficiency of all models guarantee a quick dry without energy waste.



AUTOMATIC START-UP

Fitted with an infra-red sensor that starts the product automatically when hand enter the sensor detection field. The sensor is adjustable from 8 to 12 cm through the internal trimmer.



MANUAL START-UP

Pushbutton protected against improper and violent use. Air delivery operates for 35 seconds.



DOUBLE INSTALLATION

Class II products: no earth connection is needed.



QUICK INSTALL

A drilling ruler for a quick installation is supplied in each package. Simplified and secure lock of the cover thanks to the special wrench supplied.



ECO-FRIENDLY

Combines energy efficiency with an optimal drying time.

INSTALLATION FOCUS

Height distance from the floor

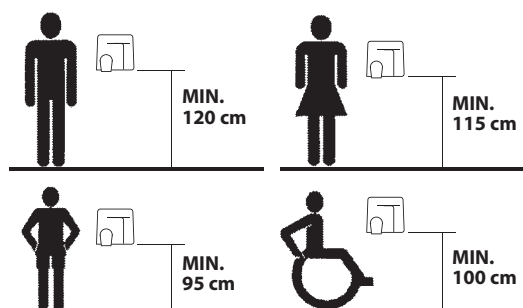

Minimum distance for serial mounting

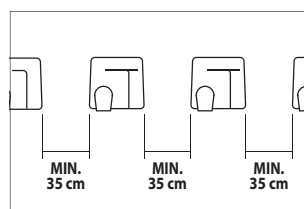

Minimum distance from the wall

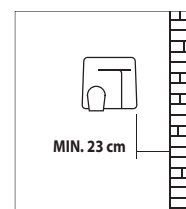

Conformity

EN 60335-1: 2002

"Safety of electrical appliances for domestic use and similar"

EN 60335-2-23 - "Appliances for skin and hair care"

EN 50366

"Appliances for domestic use and similar.

Electromagnetic fields: evaluation methods and measures"

2004/108/EC - EMC Directive (Electromagnetic compatibility)

2006/95/EC - Low Tension Directive



- Exclusive design
- ABS cover
- 4 air scatterers
- 2 IR sensors
- Drying time: 8 sec
- Air velocity: 410 km/h at 40°C
- Energy saving: no heating element



Warning lights for a quick diagnosis of the dryer.



4 air diffusion layers for an ultra-fast drying.

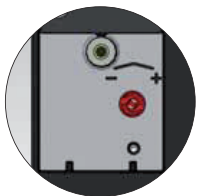

Air speed adjusting trimmer.



Water tank easily removable from the external side.

DIMENSIONS (mm)

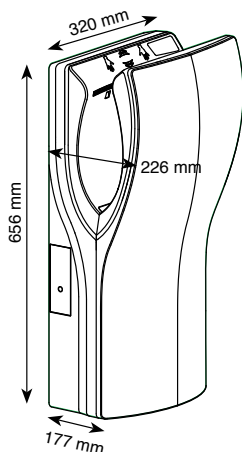

PERFORMANCE

TECHNICAL SPECIFICATION

RPM	30.000
Air velocity (Km/h)	410
Air temperature (1)	40°C
Power (W)	420 - 1.100
Consumption (A)	3,2 - 5
Noise level (dBA) at 2 m	65 - 68
Volt	220 - 240
Hz	50 - 60
Insulation	Class I
Estimated drying time	8 - 10 sec.
Weight (Kg)	8,3
Protection	IPX4

(1) The air temperature can be increased up to 45° by the means of a small resistance through an on/off switch.

FEATURES

- Hand dryer of new generation: fast drying, energy efficient, ecologic, hygienic and stylish.
- "Hands in" model. Provided with 2 pairs of IR sensors on both sides of the upper covers for instant hand detection.
- High speed motor. Motor power adjustable. Class F.
- Cover in anti-scratch ABS and aluminium impeller.
- Available in white or satin grey finish.

Eco-friendly and efficient

- Dries hand in 8 to 10 seconds according to the motor speed (adjustable via an internal trimmer).
- Low energy consumption thanks to the absence of the electric heating element: the efficient drying is given by the velocity and the type of air diffusion and not by the hot temperature as in more conventional driers.
- Lowest noise level in its category.

Hygienic and safe

- The internal surface and the water tank coated with the exclusive Biocote® antimicrobial and antibacterial protection technology based on silver ions. These ions inhibit the reproduction of micro-organisms in the product throughout its lifetime.
- No water dripping onto the floor. Water tank of 0,675 capacity, easily removable for cleaning.
- Provided with an acoustic warning for full tank.
- Easy to maintain: the front casing can be easily removed to access the internal components, quick cleaning of filters, removable water tank, with external valve for easy emptying. All as part of an ergonomic design that facilitates regular cleaning.



**Dry hands
in 8 seconds!**



- Compact, one-piece steel cover
- Sensor operated for a complete automatic operation
- Drying time: 8-12 sec.
- Air velocity: 325 km/h at 40°C
- Energy saving: no heating element



PERFORMANCE

TECHNICAL SPECIFICATION

Airflow (m³/h)	187
RPM	19.000 - 30.000
Air velocity (Km/h)	325
Air temperature (l)	40° C
Motor power (W)	420 - 1150
Consumption (A)	3,3 - 4,7
Noise level (dBA)	68-75 dB
Volt	220-240 V
Hz	50-60
Insulation	Class I
Estimated drying time	12 sec
Weight	4,7 Kg
Protection	IP23

(1) The air temperature can be increased up to 45° by the means of a small resistance through an on/off switch.

FEATURES

- Energy efficient antivandal hand driers.
- Compact, one-piece steel cover.
- IR sensor operated for a complete automatic operation. Distance detection is adjustable by potentiometer (5-25 cm).
- High-speed adjustable motor, Class F.
- Available in white or steel finish.

Eco-friendly and efficient

- Ultra-fast drying time: 8-12 seconds according to the motor speed (adjustable via internal trimmer).
- Low energy consumption thanks to the absence of the electric heating element: the efficient drying is given by the velocity of the air (325 km/h) and not by its temperature as in more conventional driers.
- Noise registered is at the lowest level among the range of high velocity fans.

Robust and safe

- Antivandal construction in steel with frame in ABS with high mechanical resistance. Provided with silent block to reduce the mechanical vibrations.
- Automatic switch off of the dryer after 60 seconds of continuous use.

DIMENSIONS (mm)

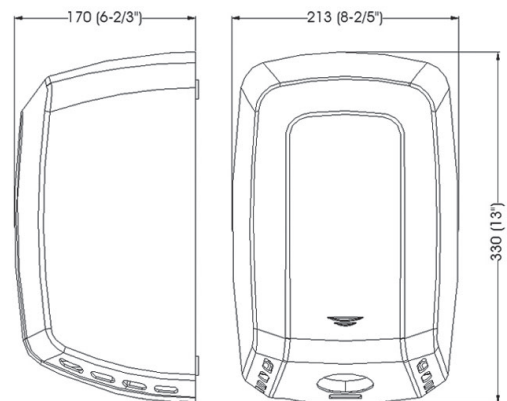



HD300

Antivandal HAND-DRYERS



HD300A

Automatic white or inox finish



Sensor operated

(adjustable through internal trimmer)
Optimized energy consumption:
immediate stop after the hands are removed.



Steel
AISI 304

HD300P

Manual white or inox finish



Push-button activation

(electronic timer with a 35 seconds cycle)

- One-piece cover stainless steel
- For high traffic facilities
- Manual or Automatic versions



PERFORMANCE

TECHNICAL SPECIFICATION

Airflow (m ³ /h)	330
RPM	5500
Air velocity (Km/h)	96
Air temperature	53°C
Motor power (W)	250
Resistance (W)	2000
Consumption (A)	10
Noise level (dBA)	68
Volt	220-240
Hz	50/60
Insulation	Class I
Estimated drying time	25 sec
Weight Kg	4,9 Kg (A) - 4,65 Kg (P)
Protection	IP23

FEATURES

- Compact, steel one-piece cover white epoxy coated and anti-scratch painted, 1,5 mm thick.
- Cover fixed to the base by means of 2 vandal-proof lock screws and locked with a special wrench supplied.
- Base in aluminium with anti-vibration supports, 3 mm thick, with 4 ø8 mm holes for wall mounting.
- Chrome-plated 360° revolving vandal-resistant nozzle, for hand and face drying.
- Warm airflow (53°C) at high velocity (96 Km/h) for a quick drying.
- Fire-resistant UL94-V0 impeller casing.
- High efficiency centrifugal impeller in aluminium.
- Waved wired NiCr heating element with self-resetable thermal cut-off.
- Universal brush motor, class F, incorporating a safety thermostat and a self-resetable thermal cut-off at 120°C.

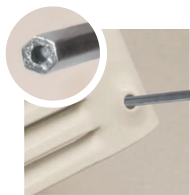

Vandal-proof lock system
(wrench supplied).



Internal trimmer
to set the sensor.



High efficiency
centrifugal impeller
in aluminium.



**360°
ORIENTATION**
Dries hands and face

DIMENSIONS (mm)

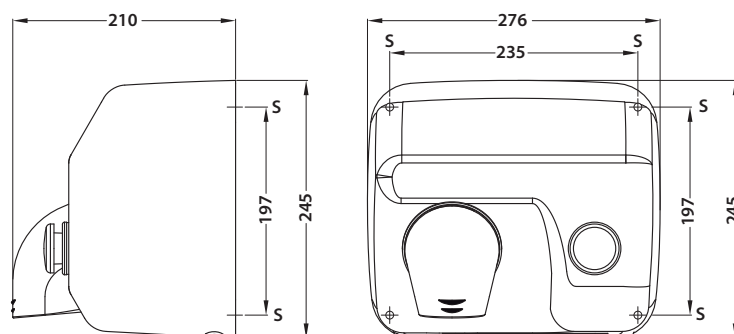



HD100

Hand Dryer CLASSIC



HD100P
Manual

HD100A
Automatic

- Classic design
- Compact
- Manual or Automatic versions
- Medium traffic facilities



PERFORMANCE

TECHNICAL SPECIFICATION

Airflow (m³/h)	240
RPM	2800
Air velocity (Km/h)	65
Air temperature	52°C
Motor Power (W)	140
Heating element power (W)	1500
Consumption (A)	7
Noise level (dBA)	58
Voltage (V)	220-240
Frequency (Hz)	50/60
Electrical insulation	Class II
Drying time	35 sec
Weight Kg	3 Kg
Protection	IP21

FEATURES

- Compact, one-piece cover made of UV resistant ABS white plastic, 3 mm thick.
- Cover fixed to the base by 4 screws.
- Air outlet grille in Zamak.
- Manual start-up through pushbutton which activates an electronic timer with a 40 seconds cycle.
- Warm airflow (52°C) at high velocity (65 Km/h) for a quick drying.
- Housing and impeller in fire-resistant ABS plastic UL 94-V0.
- Waved wired NiCr heating element with self-resetable thermal cut-off.
- Class F motor, incorporating a safety thermostat and a self-resetable thermal cut-off at 70°C.

DIMENSIONS (mm)

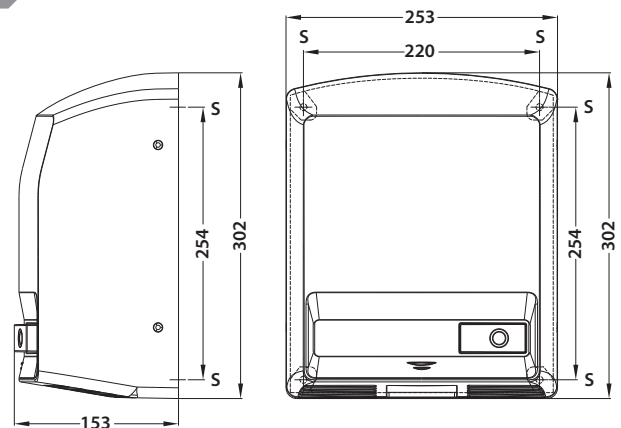

S = screw holes



HR100

Wall-mounted hair dryer



- Elegant and compact design
- Safe and efficient



PERFORMANCE

TECHNICAL SPECIFICATION

Airflow (m ³ /h)	40
RPM	15,000
Air velocity (Km/h)	79
Air temperature	60°C
Motor Power (W)	150
Heating element power (W)	700
Consumption (A)	3
Noise level (dBA)	60
Voltage (V)	220-240
Frequency (Hz)	50/60
Length tube (mm)	800 - 2000 mm
Weight Kg	1,8 Kg
Electrical insulation	Class II
Protection	IP23

FEATURES

- Quick and easy installation.
- Automatically activates when hand piece is removed from base.
- Fitted with a special security system which switches off the dryer after 15 min of use.
- High velocity airflow (79 Km/h) for a quick drying.
- White ABS plastic one-piece cover, 3 mm thick, impact-resistant and UV protected.
- The polyurethane extensible tube follows your movements while drying.
- PP UL 94-V0 helicoidal fan wheel.
- White ABS handset with a thermal protector inside.
- White ABS support and fixing.
- Motor, class B, with thermal protection.
- Waved NiCr wire heating element that incorporates a self-resetable thermal cut-off.

DIMENSIONS (mm)

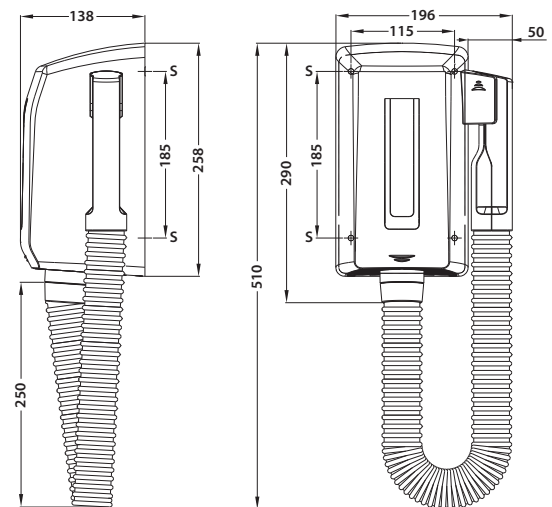



ECODRYER



Wall-mounted antivandal hair dryer



PERFORMANCE

TECHNICAL SPECIFICATION

Airflow (m³/h)	190
RPM	14.000 - 19.000
Air velocity (Km/h)	140 - 205
Air temperature (l)	45°
Motor Power (W)	200 - 1.000
Consumption (A)	2,4 - 5,2
Heating element power (W)	0 - 600 (interruttore on/off)
Noise level Lp (dBA)	65 - 73
Voltage (V)	220 - 240
Frequency (Hz)	50 / 60
Electric insulation	Class I
Weight (Kg)	5,6
Dimensions (cm)	26,5 x 42 x 17
Protection	IP23

⁽¹⁾ The air temperature can be increased to 45°C via an on/off switch connected to a small resistance of 400 W.

- Antivandal with cover in INOX AISI 304
- Compact and essential design
- Safe and efficient
- Perfect thermal insulation

FEATURES

- High speed airflow (140-205 Km/h) for a quick dry.
- Compact, AISI 304 steel one-piece cover with white epoxy coated and anti-scratch paint, 1,5 mm thick.
- Axial impeller in self-extinguishing PP UL 94-V0
- Adjustable power from 14.000 to 19.000 RPM
- Fitted with a security system that switches off the fan after 60 sec of continuous use
- Motor with thermal protection
- Safe flexible duct, thermal protected.
- Adjustable air temperature up to 45°C via an on/off switch connected to a small resistance.
- White ABS handset with a thermal protection inside.
- Complies with EN 60335-1, 60335-2-23, EN 50366, EMC 2014/30/UE and LVD 2014/35/UE.



DESCRIPTION

ECOCLEAN is an **automatic soap or sanitizing gel dispenser** ideal for offices, shops, shopping centers, schools and any public place where the level of hygiene is a risk and where it is necessary to make product dispensers available to users.

The highest level of hygiene is guaranteed thanks to the **IR sensor** that allows automatic dispensing of the liquid, avoiding direct contact of the hands with the dispenser and reducing the possibility of mutual contamination between users.

FEATURES

- Compact and essential design with surfaces easy to clean
- White quality plastic material (ABS)
- Control window on the front cover to check the soap/gel level
- LED that indicates the dispenser operation
- Battery powered (4 type AA, not supplied) for maximum flexibility of use and positioning
- Easily refillable tank with high capacity: 1 liter
- Quick and easy wall mounting
- Also available in the version with a **stand**, which can be easily positioned inside any environment



Drip mode



High efficiency sterilizing

PERFORMANCE

TECHNICAL SPECIFICATION

Dimension	262 x 123 x 114 mm (L x P x H)
Capacity	1 L
Dose Delivered	△: 0,8 ml - △△: 1,6 ml
Liquid Outlet Mode	Drip style (liquid & gel)
Refillable liquid (not included)	Hand gel, shampoo, shower gel, hand soap, etc.
Operation	Automatic touchless IR sensor
Materials	ABS, PP
Net Weight	750 gr.
Batteries (not included)	4 AA alkaline
Induction distance	Min. 3 cm - max. 10 ± 2 cm
Installation	Wall-mounted / totem or desk totem (available on request)

UPON REQUEST

NB: The stands must be ordered separately and do not include the dispenser

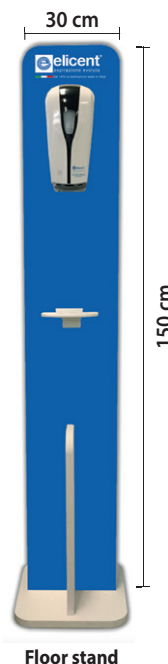

Floor stand

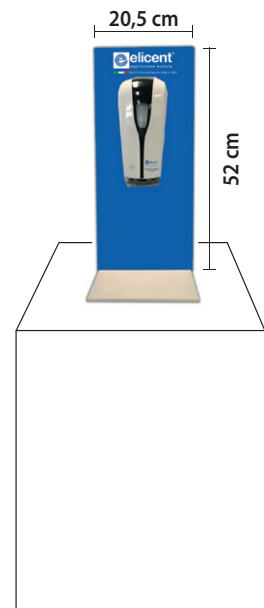

Desk stand

DIMENSIONS (mm)

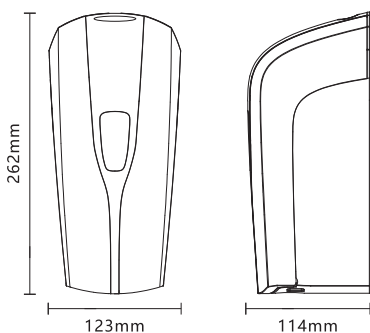

SENSORS CONTROLLERS ACCESSORIES



Sensors

Electronic controllers

Controllers with transformer

Kit local variable speed drive

Fans / Controllers pairing

R10 series SENSORS



R10 HY Remote Humidity Sensor

- The sensor **automatically** switches ON/OFF the fan according to the detected level of relative humidity, **adjustable from 40 to 90%**.
- The permanent control of the humidity level offers important advantages: maximum comfort for the user and energy saving as the fan is activated only if necessary.
- Suitable for surface and built-in installation
- Ease of connection by the means of removable terminals
- Preset holes for surface or recessed cable entry
- **Max load 4 A**
- Single-phase 230V / 50-60 Hz
- Class II protection, no earth connection is needed
- **Provided with protection fuse**
- Weight: 0,5 Kg
- Dimensions 110x80x42 mm



R10 P.I.R Remote Passive Infrared Sensor

- The fan goes on any time the sensor detects a human presence in the room
- **Provided with integral delay timer adjustable from 3 to 25 minutes**, which keeps the fan running for the pre-set period after the room is vacated
- **Ideal solution for public toilets**
- The green led indicates that the sensor is detecting
- Suitable for surface and built-in installation
- Ease of connection by means of removable terminals
- Preset holes for surface or recessed cable entry
- **Max load 4 A**
- Single-phase 117 - 230V / 50-60 Hz (different voltage upon request)
- Class II protection, no earth connection is needed
- **Provided with protection fuse**
- Weight: 0,5 Kg
- Dimensions 110x80x42 mm



CO₂ Sensor

- The fan automatically starts running when the sensor detects a CO₂ concentration included in a range from 500 to 2000 ppm
- Provided with 5 LED that indicate the level of CO₂ concentration in the air
- Voltage : 14 V - 48 V DC / 16 V - 36 V AC
- Ampere: Inom 0,02 / Imax 0,1
- Protection IP20
- Suitable for ambient temperature from 10°C to 40°C
- Dimensions (Lxpxh): 79x30x120 mm
- Weight 0,1 kg



R10

- Infinitely variable electronic speed controller by potentiometer
- New design with cover
- **Suitable for surface and built-in application**
- Ease of connection by the means of removable terminals
- External trimmer for the adjustment of the fan minimum speed
- Protection fuse
- Preset holes for surface and recessed cable entry
- Single-phase 230V – 50 Hz
- **Max. load 1A**
- Protection IP42
- Weight 0,5 Kg
- Dimensions 110x80x42



R15

- Infinitely variable electronic speed controller by potentiometer
- New design with cover
- ON/OFF light switch
- **Suitable for surface and built-in application**
- Ease of connection by the means of removable terminals
- External trimmer for the adjustment of the fan minimum speed
- Protection fuse
- Preset holes for surface and recessed cable entry
- Single-phase 230V – 50 Hz
- **Max. load 1,5 A**
- Protection IP42
- Weight 0,5 Kg
- Dimensions 138x80x42



RV1

- Electronic speed controller
- Infinitely variable speed control by potentiometer.
- ON/OFF switch
- IP42 protection
- **Max. load: 800 W (4A)**
- **Min. load: 400 W (1A)**
- Supply voltage: 230V-50 / 60 Hz
- Sizes: 110x100x58 mm
- Weight: 0,5 kg



R10 TIMER Remote timer

- **Electronic timer, adjustable from 3 to 25 minutes**
- The fan to which it is connected will overrun after switch-off for the pre-set time.
- Time adjustment via external knob
- ON/OFF light switch
- New design with protection cover
- Suitable for surface and built-in installation
- Ease of connection by means of removable terminals
- Preset holes for surface or recessed cable entry
- **Max load 4 A**
- Single-phase 117-230V / 50-60 Hz
- Class II protection, no earth connection is needed
- **Provided with protection fuse**
- Weight: 0,5 Kg
- Dimensions 110x80x42 mm



RLS 2 speeds

- **Speed control (Min/Max) and On/Off switch**
- New design with cover
- **Suitable for surface or built-in installation**
- Ease of connection by the means of removable terminals
- Protection IP42
- Weight 0,40 Kg
- Supply voltage 230V – 50/60 Hz
- Dimensions 110 x 80 x 42



RLS 3V 3 speeds

- **Remote 3 speed control (Min/Max) and On/Off switch**
- New design with cover
- **Suitable for surface or built-in installation**
- Ease of connection by the means of removable terminals
- Protection IP42
- Weight 0,40 Kg
- Supply voltage 230V – 50/60 Hz
- Dimensions 110 x 80 x 42



RVS 5 speeds

- **5 steps speed controller** (fitted with transformer)
- ON/OFF switch
- IP42 protection
- **Max. load: 100 W (0,5 A)**
- Supply voltage: 230V-50/60 Hz
- Sizes: 118 x 118 x 58 mm
- Weight: 0,7 kg



RVS/R 3 speeds

- **Reversible speed controller**
- ON/OFF switch
- IP42 protection
- **Max. load: 0,5A**
- Supply voltage: 230V-50/60 Hz
- Sizes: 118 x 118 x 58 mm
- Weight: 0,7 kg



RVS/R 5 speeds

- **Reversible speed controller**
- ON/OFF switch
- IP42 protection
- **Max. load: 0,5 A**
- Supply voltage: 230V-50/60 Hz
- Sizes: 118 x 118 x 58 mm
- Weight: 0,7 kg



RVS/R PLUS 6 speeds

- **Reversible multi controller**
- Regulation up to 5 pcs of VITRO 9 or 3 pcs of VITRO 12 contemporaneous.
- ON/OFF switch
- IP42 protection
- **Max. load: 1,5 A**
- Supply voltage: 230V-50/60 Hz
- Sizes: 158 x 118 x 76 mm
- Weight: 1,8 kg



RLS 1 WR

- **Remote controller**
- Manual selection of three modality of continuous running:
 - I - Low ventilation modality
 - II - Intermediate ventilation modality
 - III - Intensive ventilation modality
- Weight 0,50 Kg
- Dimensions 75 x 75 x 30
- **Supplied with REC in linea EC**
- **140 - 180 - 220 / REC 320**

CONTROLLERS



CONTROLLERS WITH TRANSFORMER



SPEED CONTROLLERS



TOUCH PANEL

Touch panel controller with coloured screen

The panel allows to manually or automatically activate (through the weekly programming) the following functions:

- Speed/ventilation level regulation
- Ventilation modality (by-pass function, free-cooling, only extraction, only immission)
- Threshold humidity level over which the unit increases its speed
- Post-ventilation function (Timer function, adjustable from 0 to 30 minutes) to delay the switching of the unit at the minimum speed)
- Sleep modality that allow to have the unit running silently at low speed during the night

Supplied with

- REC in linea TC 140 - 180 - 220,
- REC 320 Plus TC
- REC Smart + TC



REMOTE CONTROLLER

Remote radio controller to activate the following functions (Radio frequency 433 MHz)

Through the remote radio controller it is possible to activate the following functions:

- On/Off
- Speed/ventilation level regulation
- Sleep modality that allow to have the unit running silently at low speed during the night (the boost function is excluded)
- Post-ventilation function (Timer function, adjustable from 0 to 30 minutes) to delay the switching of the unit at the minimum speed

Supplied with

- REC Smart + RC



REMOTE CONTROLLER

Remote radio controller to activate the following functions (Radio frequency 433 MHz)

0 - On/off

1 - Push-pull operation modality

24 hours reverse flow running at the selected speed

2 - Speed 1 - Low speed set up

3 - Speed 2 - Low speed set up

4 - Boost speed with timer (extraction mode only)

5 - Sleep mode the operation at low speed is frozen for 8 hours to ensure high acoustic comfort during the night. The function can be unblocked at any time by pressing any button (except button 0).

6 - Flow control operation in intake or extract mode only.

Press once: extraction mode

Press twice: intake mode

7 - Free-cooling mode: air exchange without heat recovery

No reverse flow. Press once: the reverse flow stops and the fans go on running at the current flow. Press twice: all fans reverse their flow and go on running at the new selected flow.

Supplied with REC DUO 100 Plus RC

E-VSD



VARIABLE SPEED DRIVE

Controller that continuously adapts the electrical power supplied to the motor in order to regulate the ow rate through the control panel interface **CP-RH** or **CP-AQS**

CHARACTERISTICS

Supply: 220 - 240 Vac ; 50/60Hz.

Maxim un Power: 300 W

W a terproof: IPX4

Main materials: Aluminium cover

Selfestingishing casing (UL - 5VA) for surface mounting installation

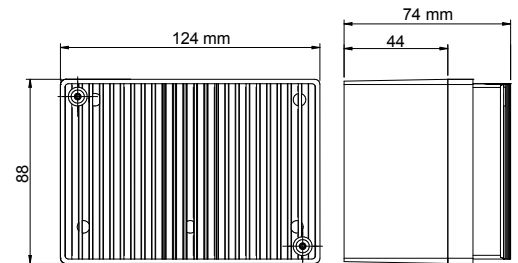

CONTROL PANEL



CP-RH



CP-AQS

CHARACTERISTICS

Control panel:

Measures a set of (control) parameters representative of the ventilation demand / quality of the indoor air.

Interface with E-VSD controller.

FUNCTION:	CP-RH	CP-AQS
Temperature control	●	●
Relative humidity detection	●	●
Air quality control		●
Continuous Speed Regulation	●	●

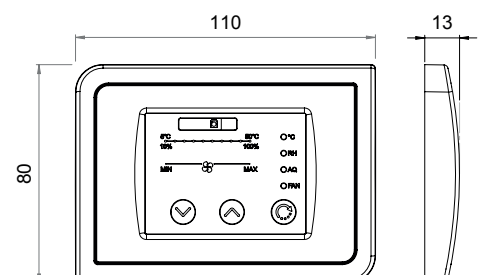

CHOOSE THE RIGHT CONTROLLER



FANS	TRANSFORMER				ELECTRONIC	BUILT-IN ELECTRONIC		
	RVS	RVS1	REVERSIBLE		RLS	RV1	R10	R15
			RVS/R 3V - 5V	RVS/R PLUS				
AXC 100 A/B - 125 A/B - 150 A - 160 A	●						●	
AXC 150 B - 160 B		●					●	●
AXC 200		●					●	●
AXC 250		●					●	●
AXC 315		●						
AXC TP 100-125-150-160	●						●	
AXM 100 - 125 - 150 - 160 - 200	●						●	
AXR	●						●	
BUILT-IN 9		●	●	MAX 5				
BUILT-IN 12		●	●	MAX 3				
ECO LINE	●						●	
ELEGANCE	●						●	
ELIX	●						●	
ELPREX	●						●	
E-SMILE	●						●	
E-STYLE	●						●	
EXT 100 - 125 - 150 A - 160 A	●						●	●
EXT 150 B - 160 B - 200 A/B							●	●
JOLLY	●						●	
FLUX	●						●	
MINISTYLE	●						●	
MURO	●						●	
MRF 100 - 125 - 150	●						●	●
MRF 160 - 200 - 250		●					●	●
MRF 315		●						
RADIA	●						●	
TUBO	●						●	
VITRO 6/150 A	●						●	
VITRO 9/230 Automatic / Reversible		●	●	MAX 5				
VITRO 12/300 Automatic / Reversible		●	●	MAX 3				

HRU	TOUCH PANEL	REMOTE CONTROLLER	RLS	RLS 3V	RLS 1 WR	CP AQS	CP RH
REC Duo 100 - DUO 100 MHY			●				
REC Duo 100 PLUS RC		● (supplied)	●				
REC Smart standard			●				
REC Smart MHY			●				
REC Smart Plus RC		● (supplied)					
REC Smart Plus TC	● (supplied)						
REC Sanair		●					
REC in linea 180 AC				●			
REC in linea 220 AC				●			
REC in linea 140 EC	●				● (supplied)		
REC in linea 180 EC	●				● (supplied)		
REC in linea 220 EC	●				● (supplied)		
REC in linea 140 EC Plus TC	● (supplied)						
REC in linea 180 EC Plus TC	● (supplied)						
REC in linea 220 EC Plus TC	● (supplied)						
REC 280 AC				●			
REC 320 EC	●				● (supplied)		
REC 320 PLUS TC	● (supplied)						
MICROBOX CONTROL+ AQS - MULTIBOX CONTROL+ AQS						● (supplied)	
MICROBOX CONTROL+ HY - MULTIBOX CONTROL+ HY							● (supplied)
MICROBOX EC AQS - MULTIBOX EC AQS						● (supplied)	
MICROBOX EC HY - MULTIBOX EC HY							● (supplied)

Accessories

	AL Back-draught shutter.	MINISTYLE E-STYLE		LIGHT KIT	POLAR
	SA Back draught shutter.	AXC MET AXC TP AXM		KIT RVS/RVS-R Built-in wall kit for RVS and RVS-R speed controllers.	
	CA Outlet connection piece with back draught shutter Ø 100-120 mm.	FLUX		FILTER Metal grease filter	E-SMILE FLUX RADIA
	SG Safety grille.	AXC MET AXM		WINDOW KIT Window kit with external fixed grille.	ECO GG ECO A
	PL Wall cover plate.	MINISTYLE ECO GG-GF-A		WINDOW KIT Window kit with external gravity shutter.	ECO GF
	WPL WALL CONNECTING PLATE for round pipe	Ø 100 mm Ø 125 mm Ø 150 mm		MGE External gravity shutter.	MINISTYLE TUBO ECO GF
	SF Kit for double window installation.	VITRO		MFE External fixed grille.	E-SMILE / MINISTYLE TUBO / E-STYLE ECO GG ECO A
	SM Kit for wall installation.	VITRO		BCR White Round grille with net.	Ø 100 mm Ø 125 mm Ø 150 mm Ø 200 mm
	SV Kit for double glazed window installation.	VITRO		BC VENTILATION WHITE ROUND GRILLE for indoor and outdoor use, for furniture, doors, fillings and vent pipes, whitout flyscreen	Ø 100 mm Ø 125 mm Ø 150 mm Ø 200 mm
	SX Wall fixing brackets.	AXC MET		Transformer for SELV products	ELIX FLUX E-STYLE
	SXP Wall fixing plate for TP centrifugal in line fans.	AXC TP		BEIP inlet/outlet round ventilation grille	Ø 100 mm Ø 125 mm
	FA Hose clamps.	AXC MET AXC TP		BEA ventilation grille	30 m3/h Ø125 mm 60 m3/h Ø125 mm
	SIL Silencers.	AXC MET		BH humidity controlled ventilation grille	10/60 m3/h
	RODS cm 30 cm 90	POLAR Evolution			

A wide range of ducts and accessories for heat recovery ventilation is also available.

**Air is like music: you can't see it but
you can surely appreciate the quality.**





Maico Italia headquarters in Lonato del Garda (Brescia), Italy



Elicent Magyarország
 1211 Budapest, Öntöde u. 6.
 Tel. +36-1-425-0353
info@elicient.hu



Member of:



We reserve the right to modify any technical data without notice.
 Different voltage and frequency upon request.

All trademarks are the property of Maico Italia Spa - All rights reserved.

Follow us:

